



USER MANUAL

BLU | Bluetooth® Wireless Detectors

WARRANTY

All Gentec-EO products carry a one-year warranty from the date of shipment on material or workmanship defects when used under normal operating conditions.

Gentec-EO will repair or replace, at its sole discretion, any product that proves to be defective during the warranty period.

The warranty does not cover damages caused by product misuse, product modifications, accidents, abnormal operating or handling conditions, or third-party battery leakage. Any attempt by an unauthorized person to alter or repair the product voids the warranty. Gentec-EO is not liable for consequential damages of any kind.

CLAIMS

For warranty service, please contact your Gentec-EO representative or fill out an RMA request:

<https://www.gentec-eo.com/contact-us/support-rma-request>

To help us answer your request more efficiently, please have your product serial number ready before contacting customer support.

Upon receipt of return authorization, ship the product according to the RMA instructions. Do not ship items without a return authorization. Transport is at the customer's expense, in both directions, unless the product has been received damaged or non-functional. Gentec-EO assumes no responsibility for the damage caused in transit.

SAFETY INFORMATION

Do not use a Gentec-EO device if the monitor or the detector looks damaged or if you suspect that the device is not operating properly.

Appropriate installation must be done for water-cooled and fan-cooled detectors. Refer to the specific instructions for more information. Wait a few minutes before handling the detectors after they are powered up. The surfaces of the detectors get very hot, and there is a risk of injury if they have not cooled.

Note: This equipment has been tested and found to comply with the limits for a Class A digital device, pursuant to part 15 of the FCC Rules. These limits are designed to provide reasonable protection against harmful interference in a residential installation. This equipment generates, uses and can radiate radio frequency energy. If not installed and used in accordance with the instructions, it may cause harmful interference to radio communications. However, there is no guarantee that interference will not occur in a particular installation. If this equipment does cause harmful interference to radio or television reception, which can be determined by turning the equipment off and on, try to correct the interference by taking one or more of the following steps:

- Reorient or relocate the receiving antenna.
- Increase the distance between the equipment and receiver.
- Connect the equipment to an outlet that is on a different circuit than the receiver.
- Consult the dealer or an experienced radio/TV technician for help.

Caution: Changes or modifications not expressly approved in writing by Gentec-EO Inc. may void the user's authority to operate this equipment.

SYMBOLS

The following international symbols are used in this manual:



Refer to the manual for specific warning or caution information to avoid any damage to the product.

TABLE OF CONTENTS

1.	BLU wattmeter	6
1.1.	Included with your BLU	6
1.2.	Introduction.....	6
1.3.	Specifications	7
1.4.	Outline drawing.....	8
2.	Quick start procedure	9
3.	User Interface.....	11
3.1.	States of the BLU and LED signification.....	11
3.1.1.	Pushbutton	11
3.1.2.	Automatic turn on with the USB cable	12
3.1.3.	Automatic turn off	12
3.2.	PC-Gentec-EO software	12
3.3.	BLU mobile application	13
3.3.1.	Install the mobile application on my phone or my tablet.....	13
3.3.2.	Open the application	13
3.3.3.	Tutorial inside the application.....	13
3.3.4.	Impact of the screen size for displaying data	14
3.3.5.	Orientation of the mobile application	15
3.3.6.	User interface.....	16
3.3.7.	Toolbar icons	17
3.3.8.	First-time connection.....	18
3.3.9.	Connecting a BLU device in the mobile application.....	19
3.3.10.	Update firmware.....	20
3.3.11.	Setting the number of digits	21
3.3.12.	Mobile application displays	22
3.3.13.	Menus.....	32
4.	Serial communication.....	39
4.1.	Description	39
4.2.	Setting up communication to the BLU.....	39
4.2.1.	Verify the COM port.....	39
4.2.2.	Connect the BLU.....	39
4.2.3.	To echo commands.....	40
4.2.4.	Test the connection	40
4.2.5.	HyperTerminal settings shortcut.....	40
4.3.	Serial command format.....	40

4.3.1. Serial protocol rules	40
4.3.2. Text mode rules	40
4.4. List of serial commands for the BLU (summary).....	41
4.5. List of Serial Commands for the BLU (Complete)	43
4.5.1. Display	43
4.5.2. Data acquisition.....	47
4.5.3. Control.....	49
4.5.4. Instrument and detector information	52
4.6. Error messages	57
5. USB driver installation.....	58
6. Maintenance.....	59
6.1. Free software and firmware upgrade.....	59
6.2. Troubleshooting	59
7. Declaration of conformity	60
8. UKCA declaration of conformity	61
9. FCC declaration of conformity.....	62
10. Appendix A: WEEE Directive	63

1. BLU WATTMETER

1.1. INCLUDED WITH YOUR BLU

The following items are included with BLU, UP or XLP series laser power detectors:

Description	Part name	Part number
BLU, UP or XLP series laser power detector		
Bluetooth dongle (USB-A)		
2 m micro-USB to USB-A cable		
Protective cover		
Calibration certificate		
Personal Wavelength Correction certificate		
Power supply and country-specific AC cable (fan-cooled detectors only)	See website	See website
Isolation tube with SM1 thread (XLP only)	XLP12-TUBE	101449

The following items can be purchased separately:

Description	Part name	Part number
Stand	See website	See website
Fiber adaptor	See website	See website

1.2. INTRODUCTION

The BLU is a series of all-in-one detectors that combines a detector and a meter in one convenient product. The small and powerful meter of the BLU series transmits your laser data through a Bluetooth low energy wireless link directly to the BLU mobile app running on your smartphone or tablet. You can also use the Bluetooth USB key supplied with your BLU power meter to connect it to the PC-Gentec-EO software on your PC. Each detector of the BLU Series offers the same incredible performance as the usual detector and meter combination, from pW to kW and from fJ to J. The good news is that all our popular products are available with the BLU option.

1.3. SPECIFICATIONS

The following specifications are based on a one-year calibration cycle, an operating temperature of 18 °C to 28 °C (64 °F to 82 °F) and a relative humidity not exceeding 80%. BLU devices must be stored in an environment between 10 °C to 45 °C (50 °F to 113 °F) and a relative humidity not exceeding 90%.

Power meter specifications	
Power range	Refer to the UP manual.
Power scales: Thermal detectors	<u>16 scales</u> : 300 µW to 100 kW
Accuracy ¹	± 2.5% ¹
Software specifications	
Please refer to the PC-Gentec-EO manual (202322). The BLU mobile app includes an in-app tutorial.	
BLU module specifications	
Battery life	In the active state, the battery life is 5 days. In the off state, the battery life is 1 month.
Maximum battery cycle count (number of charge cycles before the battery loses its efficiency)	Approximately 500 full charges (0% to 100%)
Recharge time	The battery is fully charged after 4 hours on a USB 2.0 compliant port. It charges from 0% to 80% of the charge in two hours.
Operating temperature range (for 2.5% accuracy)	10 °C to 60 °C
Maximum battery temperature	60 °C
Internal data recording	600 measurements
Wireless range	Approximately 30 m (can vary depending on the electromagnetic environment)
USB Bluetooth dongle	Included with a BLU purchase
Regulatory compliance	CE, FCC, Bluetooth SIG ² , MIC
Lithium battery transport compliance	UN: recommendations on the Transport of Dangerous Goods, Manual of Tests and Criteria, ST/SG/AC.10/11/Rev.6/Amend.1 Section 38.3 ³

¹ Including linearity, detector accuracy and is detector dependent.

² The Bluetooth word mark and logos are registered trademarks owned by the Bluetooth SIG, Inc. and any use of such marks by Gentec-EO is under license. Other trademarks and the trade names are those of their respective owners.

³ UN38.3 certificate available upon request.

1.4. OUTLINE DRAWING

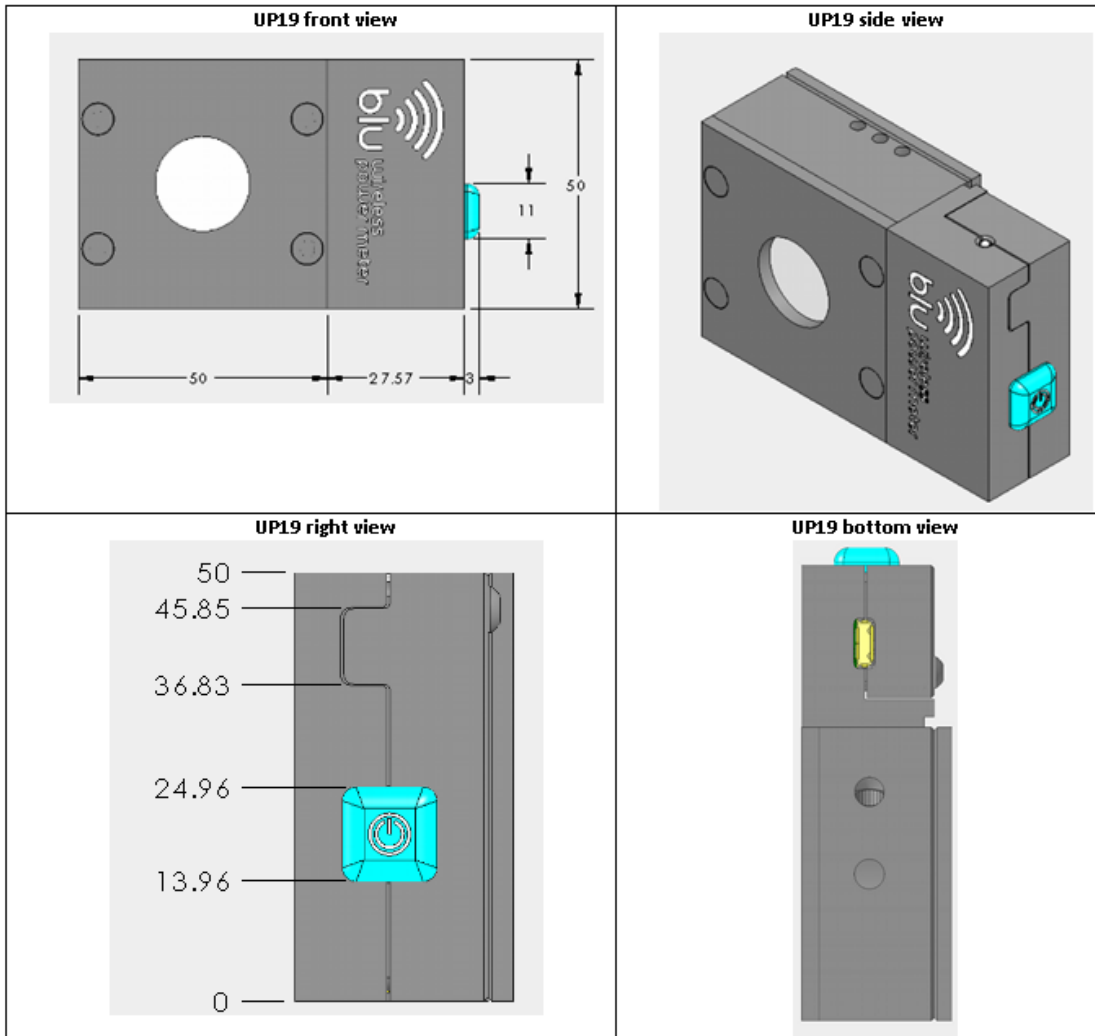
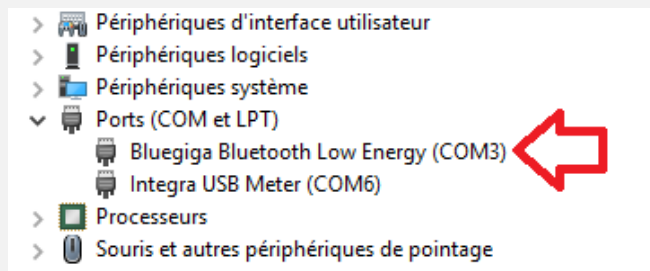



Figure 1. Outline drawing

2. QUICK START PROCEDURE

1. Install the PC-Gentec-EO software on your PC or the BLU mobile app on your smartphone or tablet.
2. Install the power or energy detector head on its optical stand.
3. Turn the BLU detector on by pressing the blue button for 1 second. Verify that the blue LED is rapidly pulsating, confirming that it is ready to connect to your BLU mobile app or PC-Gentec-EO software.
4. Start the BLU mobile app or PC-Gentec-EO software. If you are using the PC-Gentec-EO software, make sure to have plugged the supplied Bluetooth dongle into your computer. Verify that the Bluetooth dongle is correctly recognized by checking the peripheral name in your device manager. If the drivers are correctly installed, you should see the name "Bluegiga Bluetooth Low Energy (COMX)", where X is the port number.



5. Select the correct BLU device in the list of Bluetooth devices. The blue LED should now blink slowly to confirm that it is connected.
6. Choose the appropriate display for your measurement:

a.  Real time with a bar graph

d.  Averaging

b.  Scope

e.  Histogram

c.  Needle

f.  Statistics

7. Adjust the zero by clicking on the **Zero** button in the software or the mobile app. The BLU module will flash the red LED while it is taking the zero.

The power read by PC-Gentec-EO or by the BLU mobile app when no laser beam is incident to the detector may not be exactly zero. For power measurements, this is because the detector is not thermally stabilized or there was a heat source in the field of view of the detector when you connected the PC-Gentec-EO.

See *notes*.

Notes:

- a. Refer to specific power detector documentation for complete installation and operating instructions.
- b. Power detectors are thermal sensors and are thus sensitive to temperature variations.
- c. For high-precision measurements, it is recommended that you:
 - i. Allow the power detector to thermally stabilize before zeroing the software.
 - ii. Touch only the stand when handling the power detector. Do not touch the detector itself. This is especially true for highly sensitive detectors.
 - iii. Avoid forced airflow or air drafts around the detector.

3. USER INTERFACE

3.1. STATES OF THE BLU AND LED SIGNIFICATION

The BLU current state is represented by the bicolour LED on the top of the module. The BLU state can be changed by pressing the pushbutton or by using software commands.

- If the blue LED is closed, the BLU is off. In the off state, the red LED can still be on to indicate that the battery is recharging.
- If the LED is flashing rapidly blue, the BLU is active and searching for a connection to a mobile BLU app or to a PC-Gentec-E0.

	On 40 ms Off 250 ms
---	------------------------

- If the LED is flashing slowly blue, the BLU is active and connected to a mobile device or a PC.

	On 5 ms Off 2 s
---	--------------------

- If the LED is flashing red rapidly a few times (around 8 times), the BLU is doing a zero.

	On 40 ms Off 250 ms
--	------------------------

- If the LED is continuously red but dimmed, the BLU is recharging the battery.

	On continuously dimmed
---	---------------------------

- If the LED is flashing red slowly three times in a row, there is an over-temperature condition on the battery (60 °C by default).

	On 5 ms Off 2 s
---	--------------------

- If the LED is solid red, a communication error has occurred.

	On continuously Full intensity for 2 sec
---	---

3.1.1. Pushbutton

The pushbutton on the side of the BLU module allows the user to turn on and off the BLU. Upon turning on, the BLU automatically performs a zero, so the red LED will be flashing for about 3 seconds.

3.1.2. Automatic turn on with the USB cable

The BLU will automatically turn on if a USB cable is inserted into the connector. This will also cause the BLU to take a zero at the start-up. The BLU can still be turned off by pressing the pushbutton if no measurements are required. The red LED will still be on if the charge is incomplete.

Note: Connecting the USB while the BLU is continuously acquiring data on the battery will result in a small offset error. If acquiring data for a long period of time, please use the USB cable for the whole acquisition to not induce the offset error.

3.1.3. Automatic turn off

If the BLU is searching for a connection for more than 5 minutes, the BLU will automatically turn off to save battery power. It can then be turned on by pressing the pushbutton or by inserting the USB cable as usual. If the BLU is communicating with the PC-Gentec-EO software through a USB and not with the Bluetooth, removing the USB cable will obviously cause a loss of communication data, and this will turn off the BLU to save battery power.

3.2. PC-GENTEC-EO SOFTWARE

Please refer to the PC-Gentec-EO manual for more information concerning the user interface. The manual can be downloaded on our website at <https://gentec-eo.com/downloads/specsheets-manuals>.

3.3. BLU MOBILE APPLICATION

3.3.1. Install the mobile application on my phone or my tablet

The BLU mobile application from Gentec-EO is available on both Google play and Apple App Store applications.

Apple App Store



Open the App Store on your device and search for Gentec-EO. Install the BLU mobile application.

Android Google Play Store



Open Google play on your device and search for Gentec-EO. Install the BLU mobile application.

3.3.2. Open the application

Tap the icon of the application to open it.

3.3.3. Tutorial inside the application

Before explaining all features of the BLU mobile application, please note that inside the application, a short tutorial is always available to introduce the software. This tutorial is located in the **About** menu of the application. To access it, swipe the left side of the screen or push the hamburger menu on the top left and choose **About**. Then, press on the tutorial blue link.

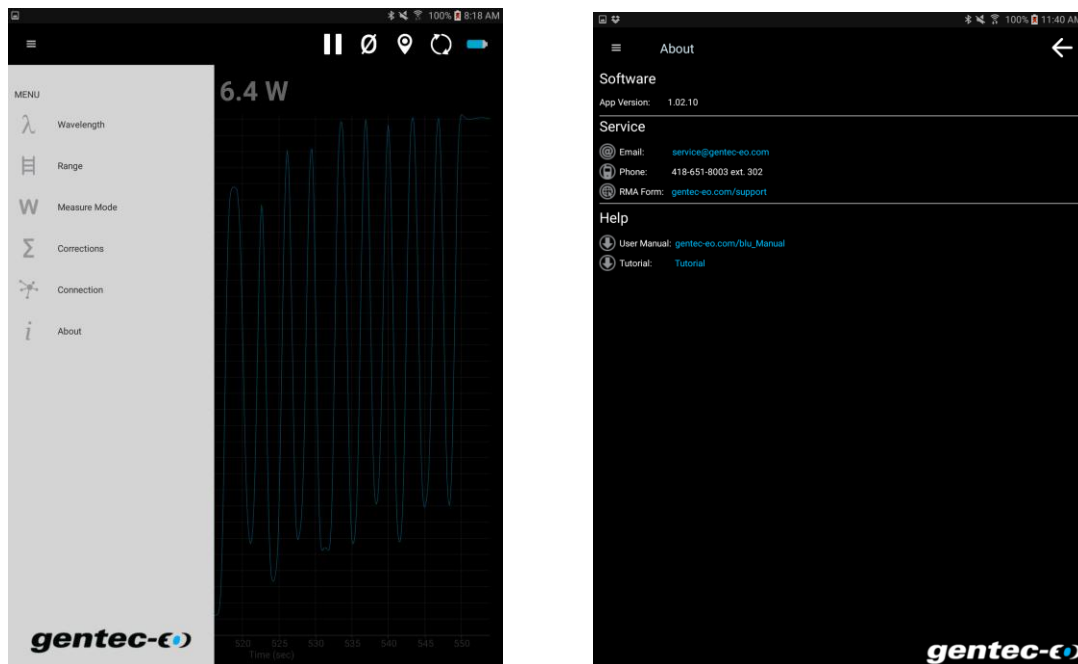

Figure 2. Access the tutorial inside the mobile application

3.3.4. Impact of the screen size for displaying data

The BLU mobile application is available for all mobile device form factors, from small phones (e.g., iPhone 4S) to very big tablets (e.g., iPad Pro). The user interface of the BLU application will adapt itself automatically, and the same information will be available.

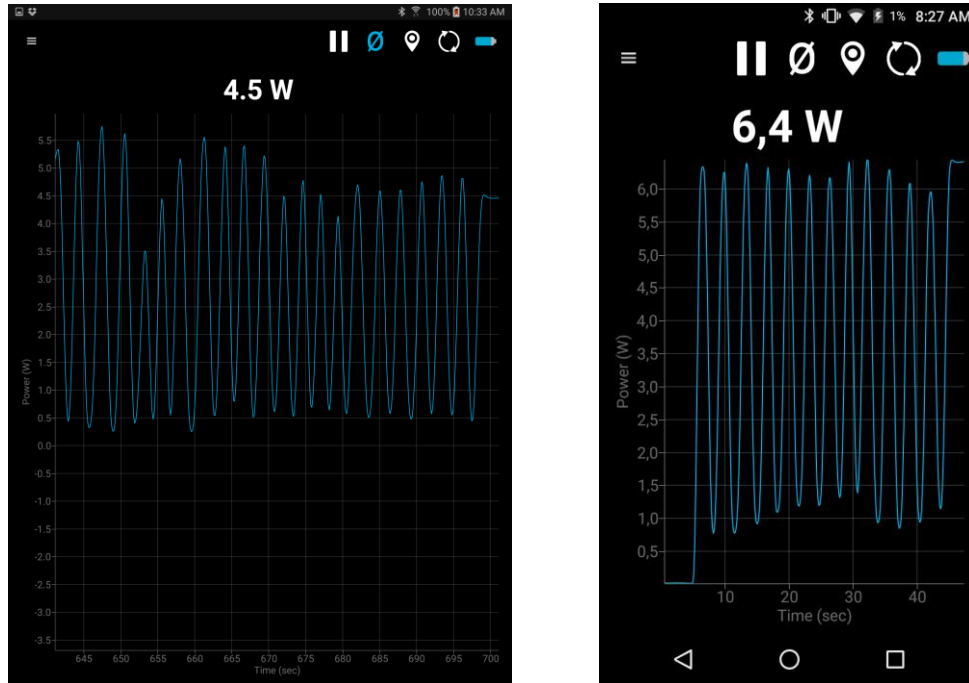

Figure 3. Screen form factor for a tablet (Samsung Galaxy Tab) and a smartphone (BLU Advance Smartphone)



Warning

The BLU mobile application has been designed to work with iOS and Android devices. This user manual uses print screens from an Android Samsung Galaxy Tab tablet. Form factors, menus and the look of the interface could change slightly between each device and also from Android to iOS.

3.3.5. Orientation of the mobile application

At any moment and everywhere in the BLU mobile application, landscape or portrait orientation can be chosen. The application will simply adjust itself to the phone or tablet orientation. To lock the orientation, please refer to the user manual of your mobile device.

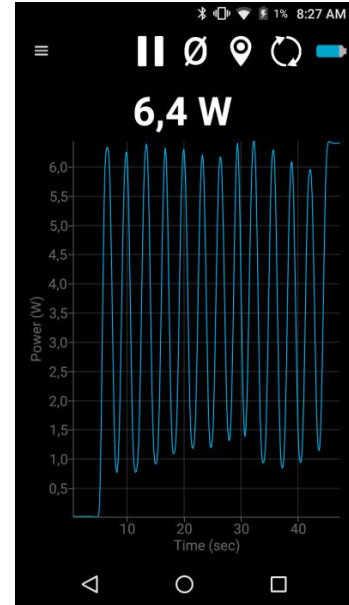
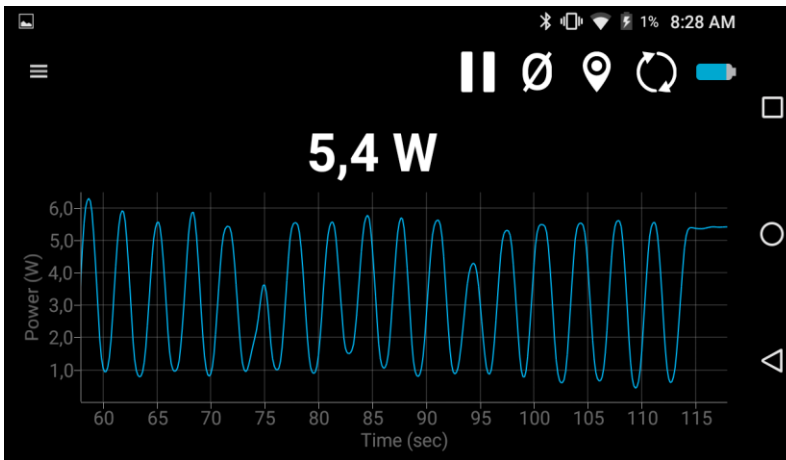

Figure 4. Orientation of the mobile application

3.3.6. User interface

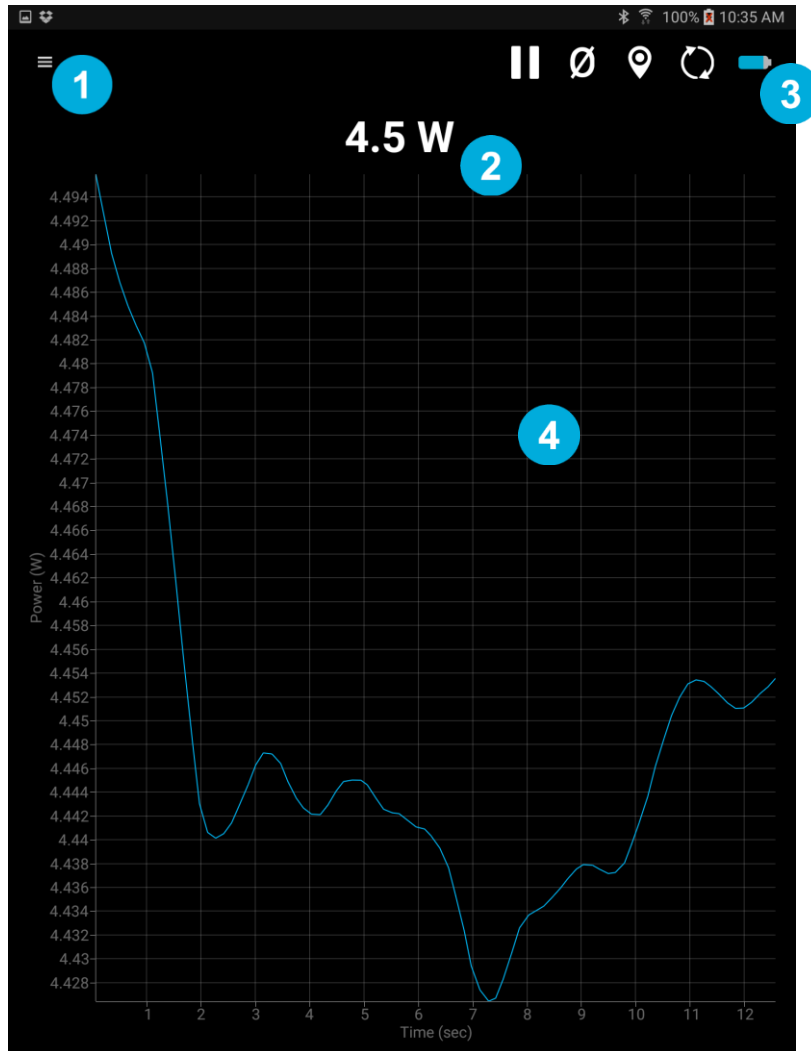

Figure 5. User Interface principles

- 1 Menus**
All the settings for the BLU device are available by tapping the hamburger menu: **Wavelength, Range, Measure mode, Corrections, Connection, About.**
- 2 Last value**
Real-time display of the last value available on each display.
- 3 Toolbar icons**
Action button that will trigger action on each display.
- 4 Display**
This section of the software displays the value in the user's selected display mode. Only one display at a time is allowed.

3.3.7. Toolbar icons

In each display, a series of icons is available on the top right.

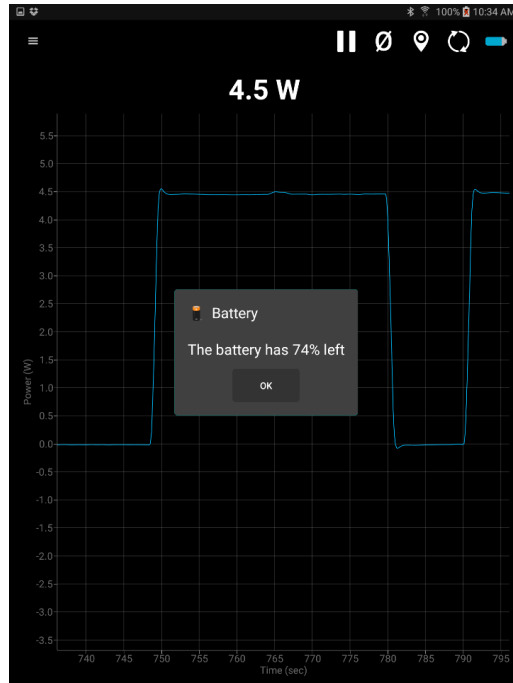

Figure 7. Toolbar icons and a sample of the battery indicator

Below is the description of each action available in the different displays.

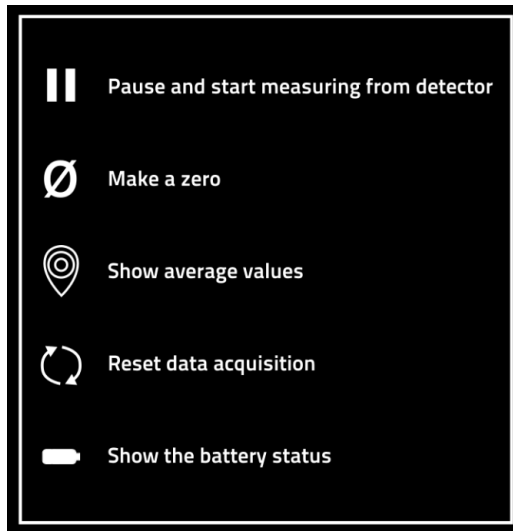

Figure 8. Toolbar actions description

3.3.8. First-time connection

The BLU mobile application cannot fully identify a BLU module unless it has already been connected at least once. On the connection display of the application, your BLU power meter will be identified as **Laser Detector** with numbers representing the MAC address of the BLU. This is shown in the image below with red arrows. Next time you connect to the BLU, the mobile application will correctly identify it and will change the generic "Laser Detector" name to the type of power you have. The MAC address will also change to show the serial number of the device instead. Both of these changes are represented in the image below with green arrows.

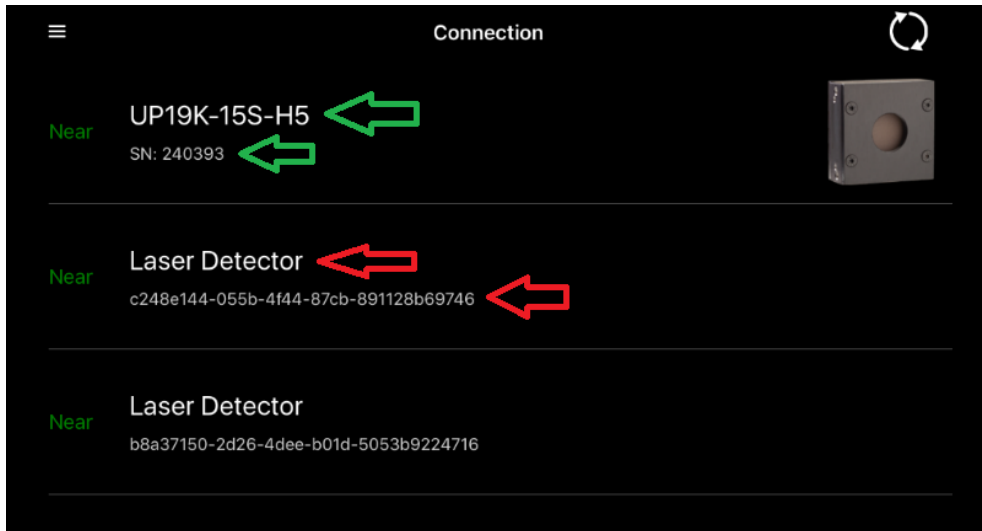

Figure 9. First-time connection

3.3.9. Connecting a BLU device in the mobile application

Connecting a BLU device is really simple in the mobile application. Just open it, wait a second for it to automatically search all available devices and then tap on the desired device. An animation will be on the screen for a few seconds, and then the BLU will start automatically to acquire data. The delay between the tap and the acquisition is due to a complete setup of the BLU device before making the acquisition. A factory reset is done before beginning the acquisition. This will ensure the BLU device is in a perfect situation at each connection.

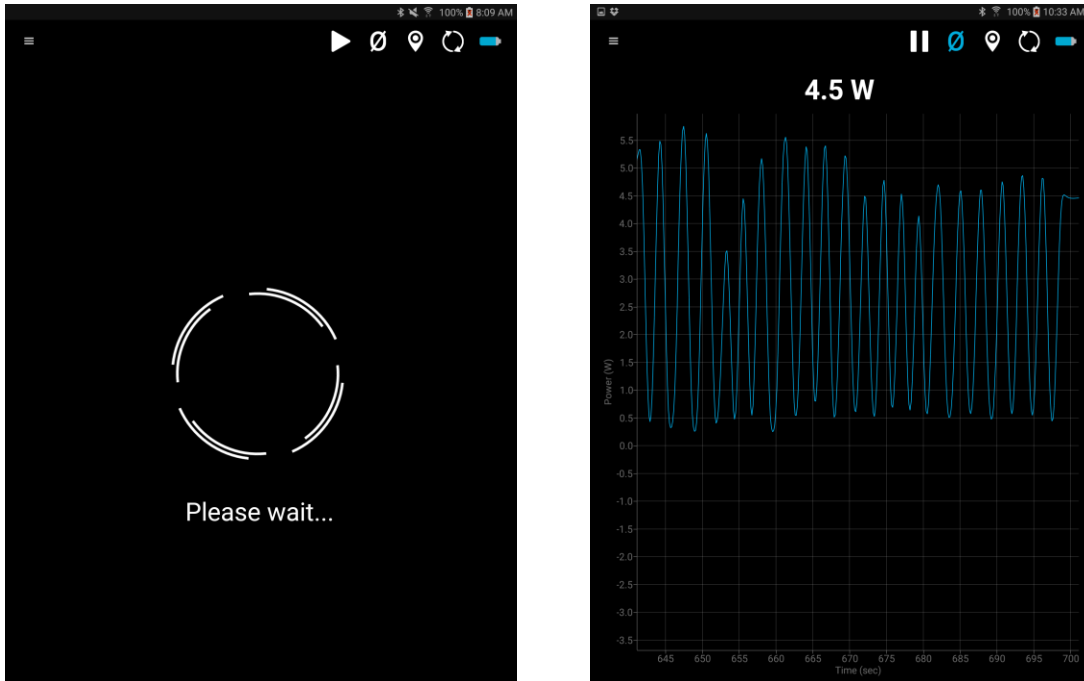

Figure 10. Waiting for the acquisition to start after device selection

3.3.10. Update firmware

If new firmware is available for the BLU device, the BLU mobile application will detect it after a connection and will ask automatically to update it now or later. When the update begins, a “Please Wait” dialog will appear. Updating the firmware takes a long time, between 45 seconds and 5 minutes, depending on the mobile device and the distance between the BLU device and the mobile device.



Tip

BLE is a wireless short-range technology. Before updating the firmware, put the two devices as close to each other as possible. This is the best way to ensure a fast update.



Warning

Avoid interrupting communication when updating the firmware.

If this happens, the BLU device will not be available before the update is complete. It is possible to restart the update at any time if an interruption occurs. To do so, reset the BLU device and the BLU mobile application and start the communication again between the two devices. The update will restart automatically.

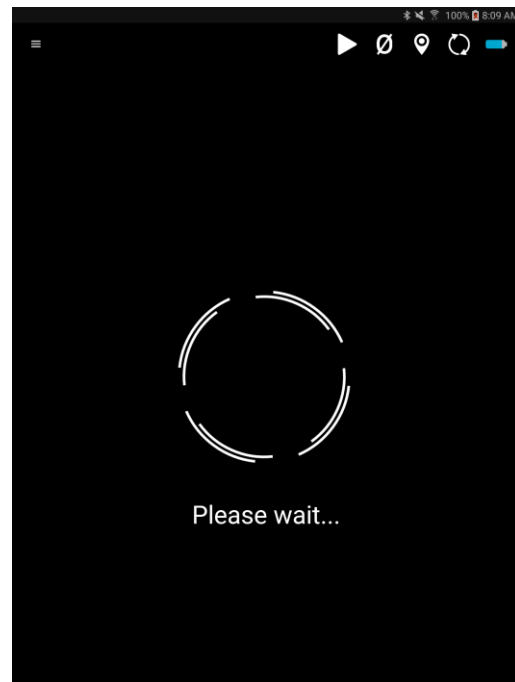
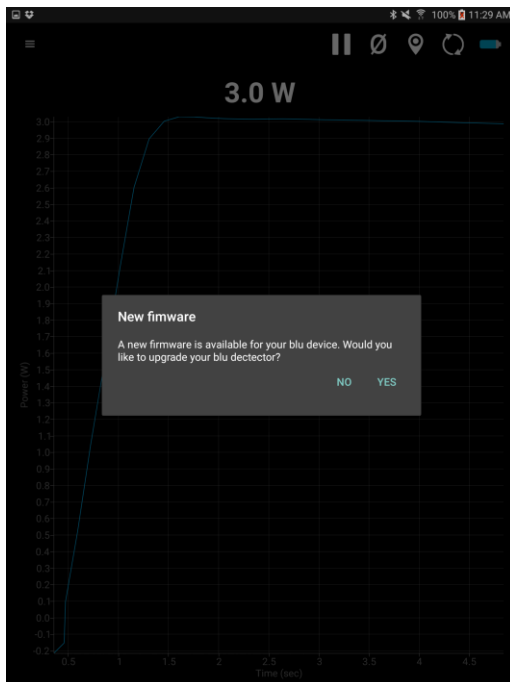

Figure 11. Dialogs asking you to update the firmware, and the wait dialog that will appear after selecting yes

At the end of the firmware update, a dialog will appear to close the application. Closing the application is mandatory before connecting the two devices again.

3.3.11. Setting the number of digits

Changing the number of digits is easy. In any display, tapping the last value will increase the number of digits. One, two, three or four digits are available. Tapping the last value when it has four digits will reset the number of digits to one.



Figure 12. Tap the Last Value to set the number of digits

3.3.12. Mobile application displays

Five different displays with unique features are available in the BLU mobile application: scope, needle, real time, statistics and acquisition. Each display will be covered in this user manual.



Figure 13. Scope and needle display

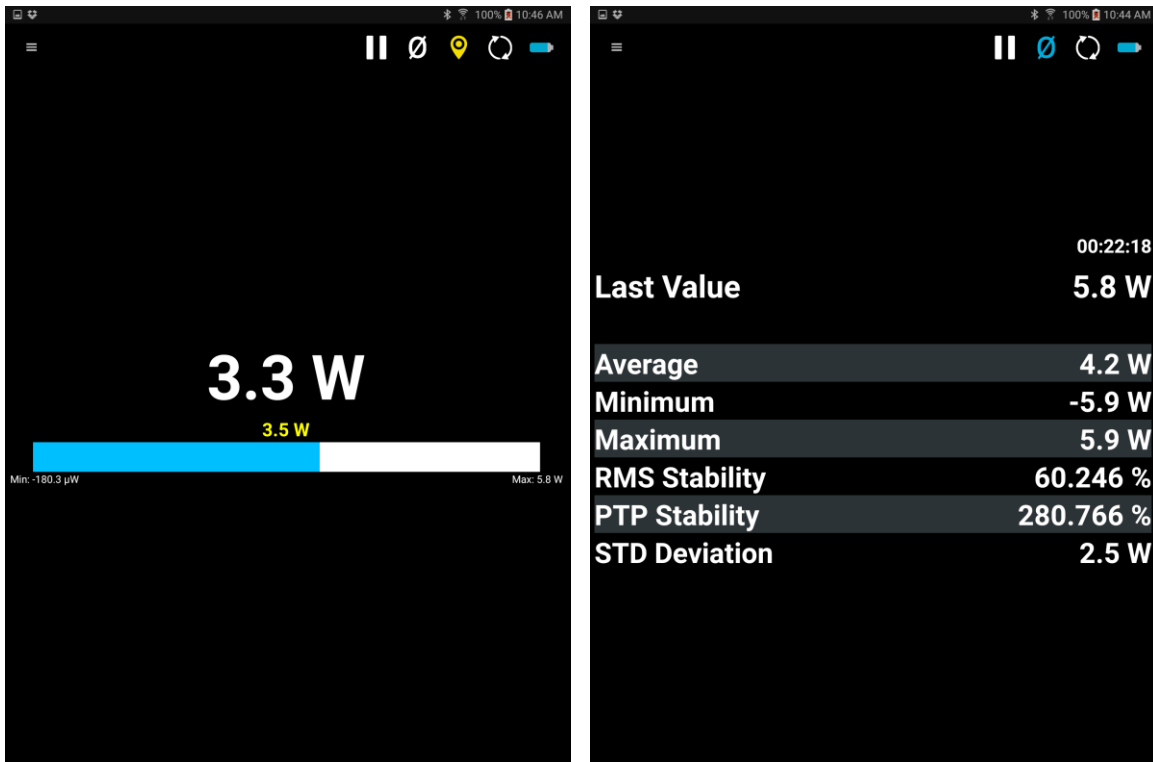

Figure 14. Real-time and statistics display

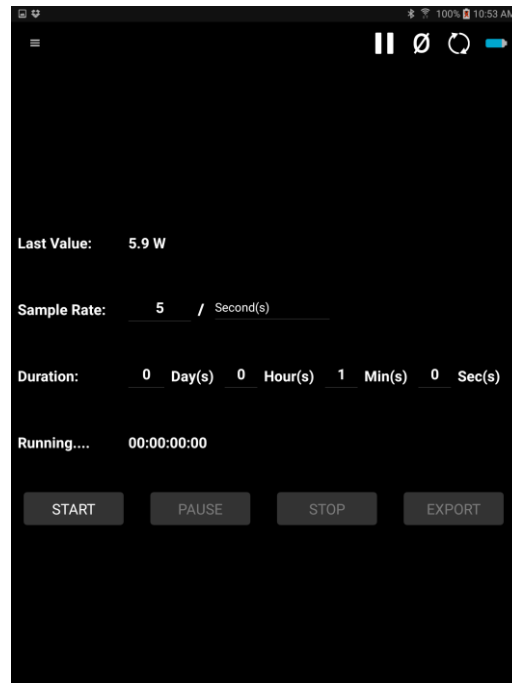

Figure 15. Acquisition display

See the evolution in real time of your signal as you would see on an oscilloscope. The display shows the last 60 seconds, but remembers the last 5,000 values. After 5,000 values, the memory will begin to replace them, starting with the first value.

Zoom actions

It is possible to show the values before the last 60 seconds. To do so, tap the pause icon in the toolbar. Then, it is possible to go back and forward using your finger. It is also possible to zoom in and out by pinching with two fingers. Finally, it is possible to double-tap and drag a region of interest into the scope. At any time, it is possible to double-tap anywhere or press the reset icon in the toolbar to reset the zoom.

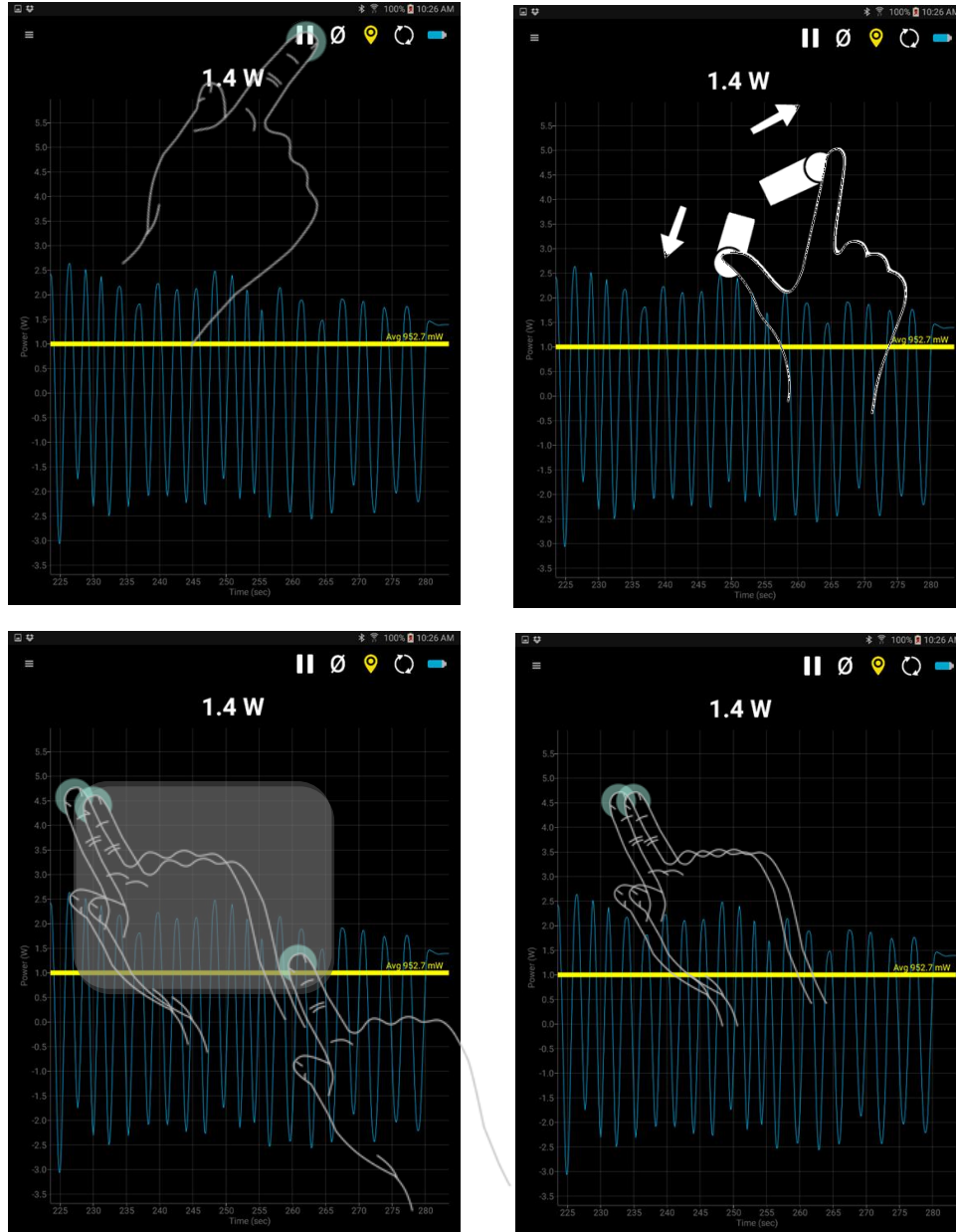

Figure 16. Pinch actions

Autorange

By default, the BLU starts in autorange. The scope display does the same thing, so the minimum and the maximum since the beginning of the acquisition or since the last reset are always available on this display. To change the autorange to a fixed setting, open the menu and choose **Range**, then choose a specific range and go back to the scope display. It will be automatically set up from 0 to the range chosen.

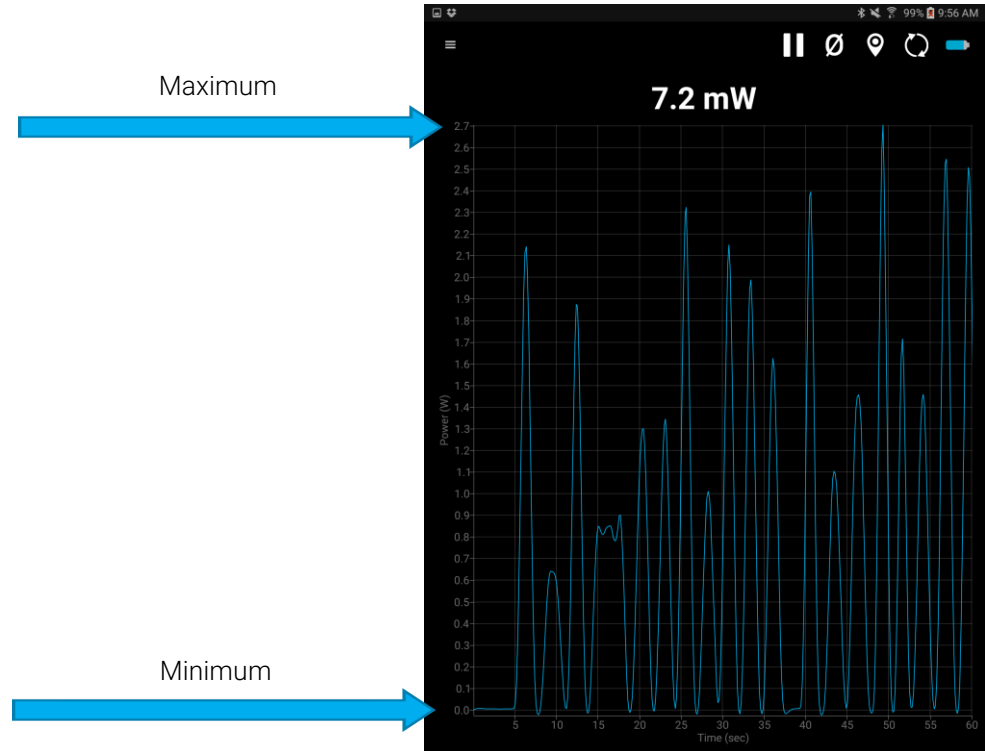

Figure 17. Autorange

Average

This mode can also show the average value of your signal since the beginning of the acquisition or since the last reset. To activate the average view, tap the marker icon in the toolbar.

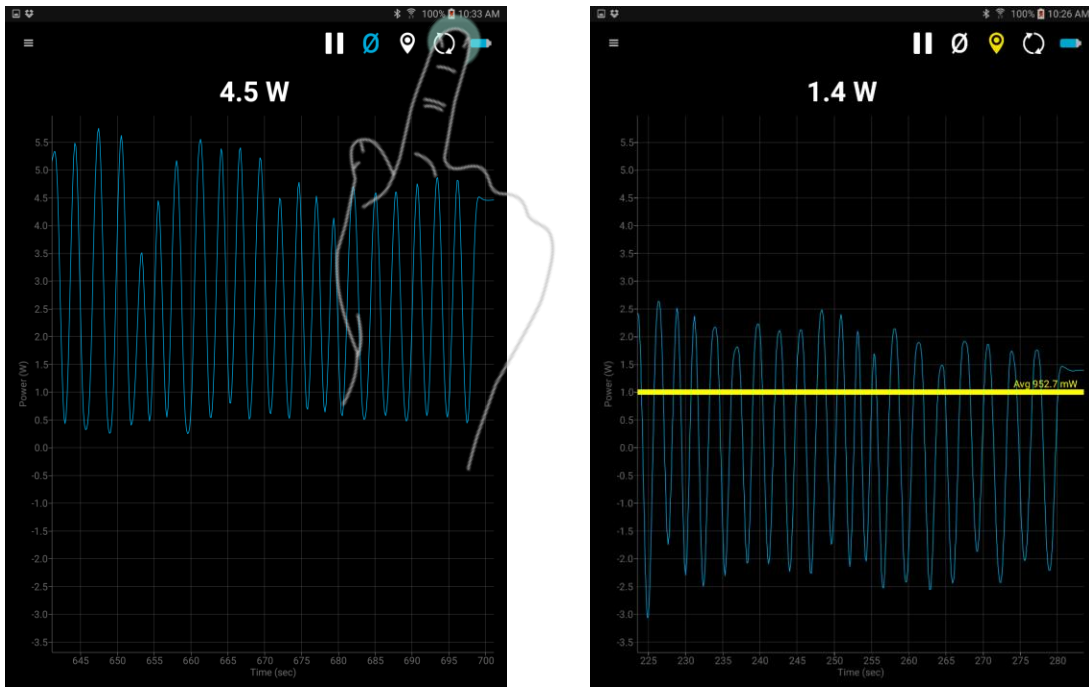

Figure 18. Scope display without and with the average view

Needle display

This is a simple and intuitive way to see your current signal value. It is the ideal tool for laser tuning.



Figure 19. Average in the needle display

Real-time display

A big, simple, real-time value with a bar graph that allows you to see what is going on in real time. The big digits make it perfect to read from a distance.

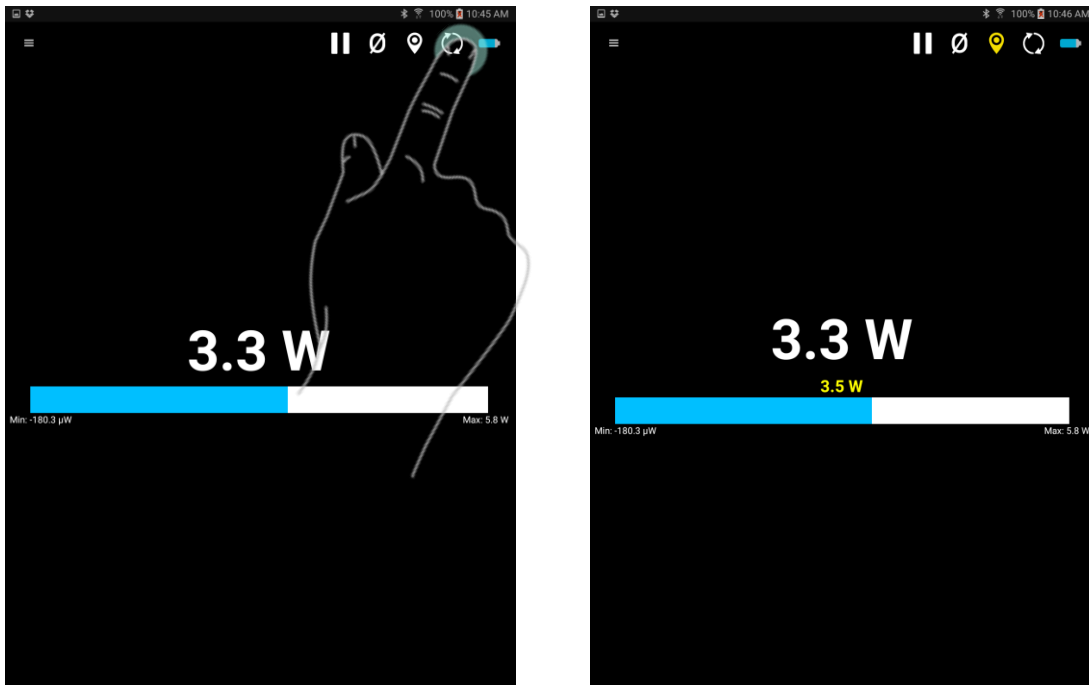

Figure 20. Average in the real-time display

Statistics display

Statistics in the PC-Gentec-EO software are calculated from the values that come from the BLU device.



Warning

Statistics in the BLU mobile application are calculated from all the entry points coming from the BLU device. Depending on the distance and the mobile device, this can be different from the number of points received by the monitor. Please refer to the **Specifications**.

	00:20:00
Last Value	5.8 W
Average	2.1 W
Minimum	1.5 W
Maximum	5.9 W
RMS Stability	69.208 %
PTP Stability	205.535 %
STD Deviation	1.5 W

Figure 21. Statistics display

Acquisition display

Sending the acquisition a memory file. The different options for the acquisition are found in the display. The BLU device must be connected to start the acquisition.

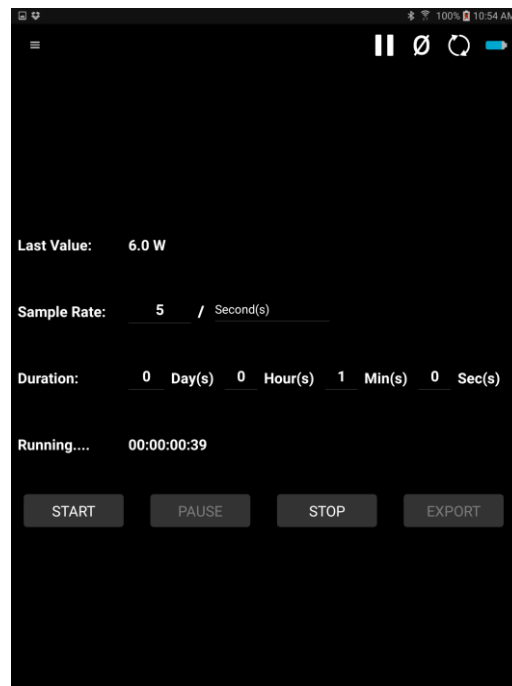

Figure 22. Acquisition display

The different options for the acquisition can be found in the display. The BLU device must be connected to start the acquisition.

Start: starts the acquisition.

Stop: stops the current acquisition.

Pause: pauses the current acquisition.

Export: allows the sharing of data collected.

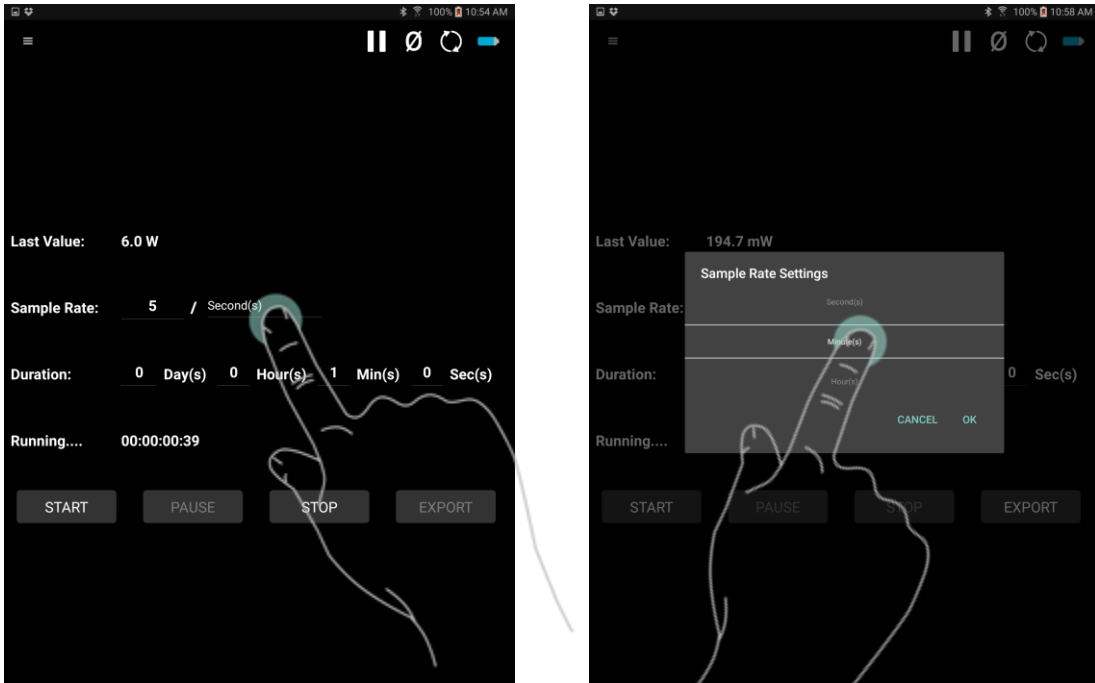

Figure 23. Acquisition display - tap to change a setting

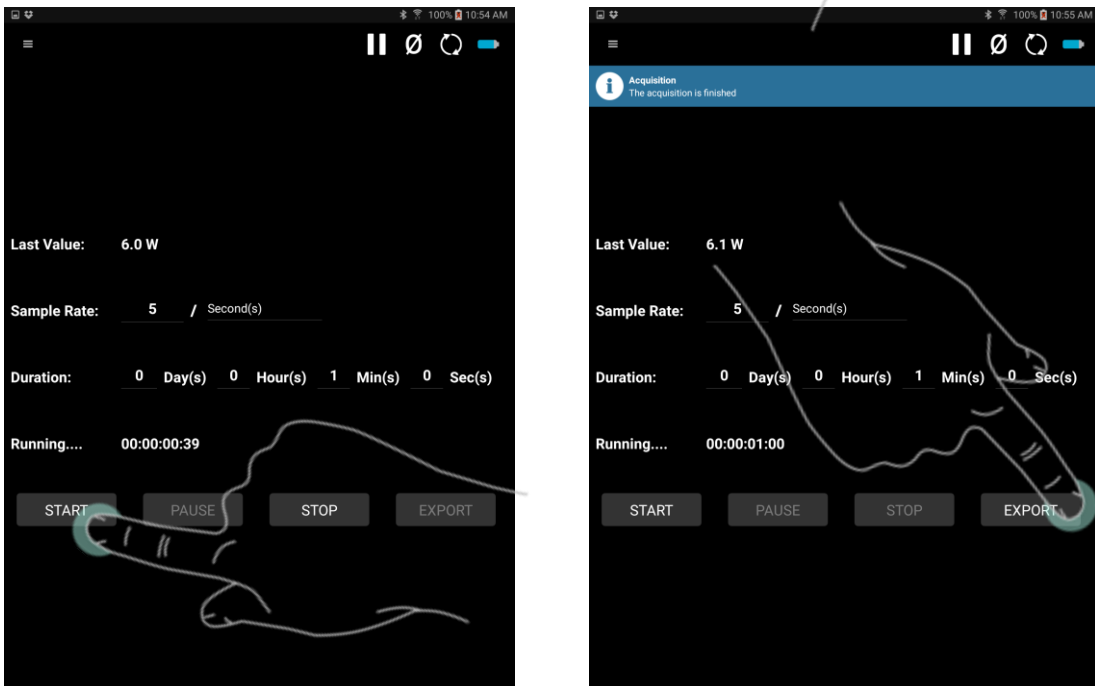

Figure 24. Acquisition display - tap the **Start** button; when the acquisition is over, tap the **Export** button

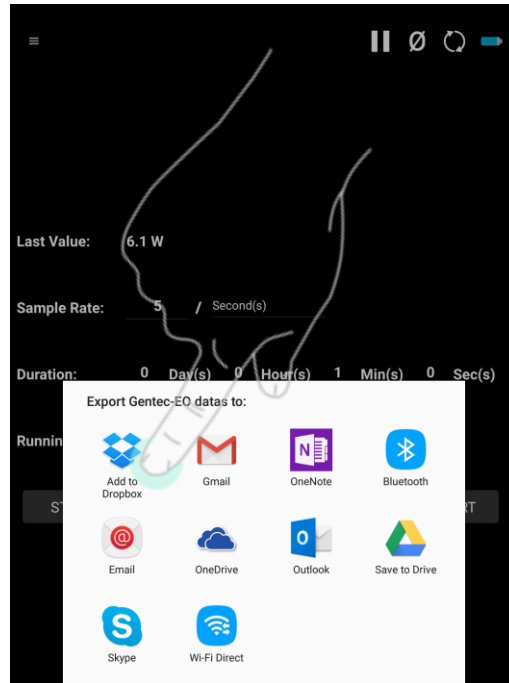

Figure 25. Acquisition display - choose the desired service to export the data



Warning

Every Android and iOS that supports "txt" import will be available. If the mobile device does not have any application that supports "txt" import, this menu may be empty. If this occurs on the mobile device, please use the Google play store or Apple App Store to install an application that will support "txt" import, such as Dropbox or Google Drive.

3.3.13. Menus

Wavelength

The **Wavelength** menu is used to select the proper wavelength at which the detector is used. It applies a correction factor to compensate for the variation in absorptivity at different wavelengths. Pre-programmed wavelength correction factors specific to each detector are available and automatically loaded from the EEPROM of the detector (for detectors of version 5 and higher). When a new detector is plugged in, the calibration wavelength is the default selection.

The BLU mobile application automatically recognizes the latest energy and power detector for accurate auto-calibration. More importantly, it takes advantage of our Personal Wavelength Correction certificate.

The BLU mobile application only allows you to choose values that fall within the detector's range. If you enter an invalid value, a menu pops up to signal the error, and the BLU mobile application automatically selects the default value, which is the wavelength used for calibration at Gentec-EO during manufacturing or subsequent service.

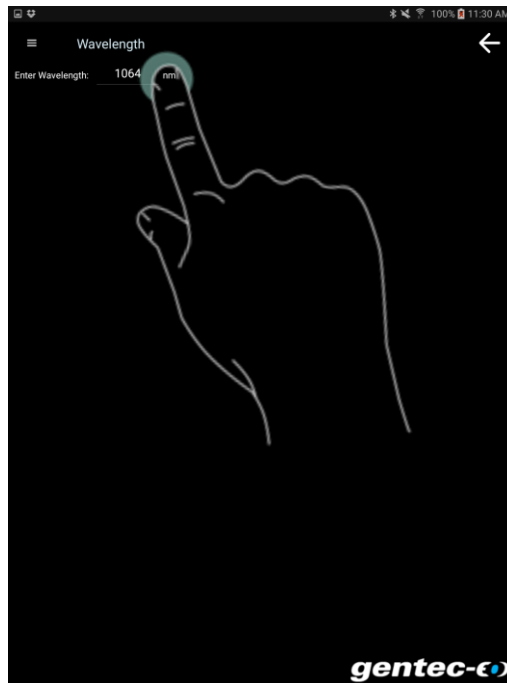

Figure 26. Wavelength setting - tap the wavelength to change the value

**Tip**

The Personal Wavelength Correction certificate

To fill the gaps between the NIST references, Gentec-EO offers you the only NIST traceable calibration in nm steps, from 250 nm to 2.5 μm . We achieve this using our proprietary setup that is based on a NIST traceable spectrophotometer. This way, instead of supplying you with typical values, we offer you a NIST traceable calibration. What you get is an overall accuracy that is not more than $\pm 1\%$ away from the original calibration accuracy, in the spectrum of 300 nm to 2200 nm.

Each Gentec-EO detector comes with a Personal Wavelength Correction certificate. The correction factors are based on measurements that were made with YOUR detector. They are not based on the general curve of the absorbing material or the general response of equivalent products. This means you get the best wavelength correction tool available on the market. This data is stored in the smart interface of your Gentec-EO detector. You just have to select the wavelength in your monitor (or software) to get the most precise laser measurements on the market.

Range

The **Range** menu is used to select the signal level read by a detector. When a new detector is plugged in, the **Auto** mode is the default option. In this mode, the BLU mobile application automatically selects the best range for the value being measured. You can also choose a fixed range. The BLU mobile application only shows range values that fall within the detector's range. You can only choose from these available ranges.

When in a manually selected range, you should always use the next higher range to the measured value for maximum precision. For example, when measuring around 200 mW, choose the 300-mW range.

Special care must be taken in the case of widely varying pulse energies to ensure that every pulse is detected. Contrary to power measurements, where the **Auto** mode continuously adjusts the range to the measured value, in **Energy** mode, the autorange selects the range based on the energy of the previous pulse. A pulse with energy less than 2% of the current range will not be detected. Always set the range to the best one available. To be sure to measure lower energies, set the range manually to the lowest level or use the autorange so the BLU mobile software automatically chooses the best range. In this case, the pulses that saturated the range while the autorange was searching for the best range will be invalid.

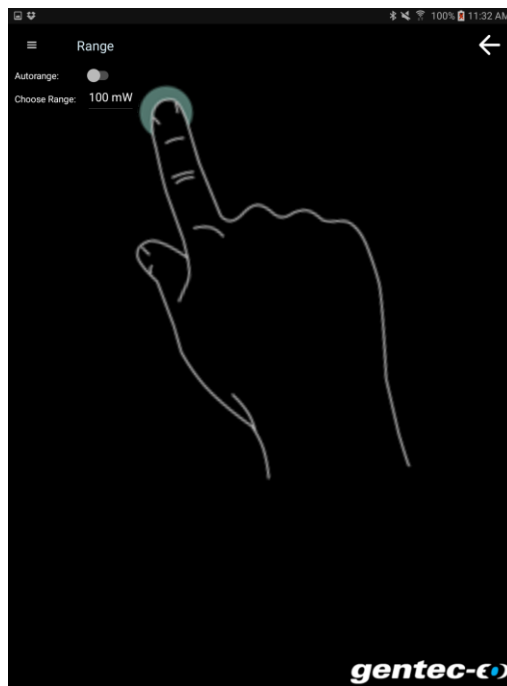

Figure 27. Range setting - tap the range to change the value or tap the **Autorange** switch to toggle between autorange and a fixed range

Measure mode

- Power in watts (default)
- Single-shot energy in joules¹: (**Energy mode/Calorimeter mode**)

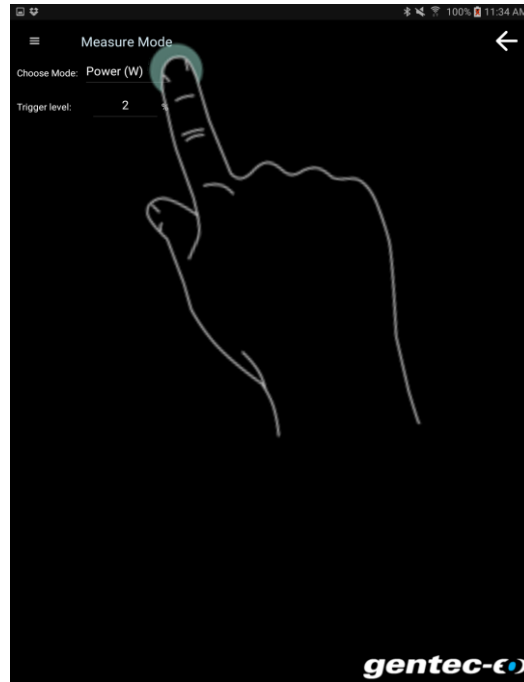

Figure 28. Measure mode setting - tap **Measure Mode**

¹ This function allows you to measure the energy contained in a laser pulse with a Gentec-EO power detector. This mode of operation gives access to the same options as an energy detector. The only restriction is that the time delay between

pulses, $Delay = \left(\frac{1}{Rep. Rate} \right)$, must be compatible with the specifications of the detector. (Please refer to the user manual for the

specific power detector you are using.). You must select the range manually because the autorange is deactivated when you select **Energy** mode. Keep in mind that the power detectors are optimized to sustain high average power, not high peak energy. Always keep the energy density below the maximum energy density quoted in the manual for that specific detector. The **Energy** mode is always available for power detectors with a typical sensitivity value. A precision of $\pm 3\%$ in the pulse energy measurement can be achieved if the power detector is specifically calibrated in **Energy** mode. Please contact your local Gentec-EO distributor or nearest Gentec-EO office for more information on obtaining a pulse energy measurement calibration.

Corrections

The user can apply a multiplier or an offset to the measurements. Correction factors are most useful when sampling a percentage of a powerful laser beam or correcting for absorption along an optical chain.

The default value for the multiplier is 1, and the default for the offset is 0. You can enter any multiplier value between 0.0002 and 5000 and any offset value between -10,000 and +10,000. To change the value of the correction factors, you first need to activate them by checking the appropriate box.



Example

Adjusting your measurements using correction factors

Let's say you are measuring a laser beam passing through the 99.9% back reflector of a laser (giving 1/1000th of the real value), choose **Multiplier** and enter 1000 in the dialog box. The PC-Gentec-EO software will display the laser power rather than the measured 0.1% sample.



Warning

It is essential to make sure that the actual measured value also complies with the power and energy limits of the detector.

The **Autorange** option is the default selection. You can select a specific range, but it must always be based on the actual measured values and not on the corrected values. Of course, the displayed values and the display range selection are then calculated to take into account the correction factors.



Tip

The statistics are computed for the corrected values only.

The trigger level only works if a power detector is used in **Single-hot energy (SSE)** mode. This option allows you to change the trigger level. The default value is 2% of the full range. This proves to be especially useful in noisy environments. Acceptable values range from 0.1% to 99.9% with 0.1% steps. Caution should be taken when choosing a trigger level lower than the 2% default value in a noisy environment.

The BLU mobile application will not detect pulses with a value under the trigger level. If the trigger level is high, be careful to select a range that is close to the measured value. To reset the default value to 2.0%, simply click the **Default** button.



Warning

If you select a high-value trigger level, the BLU mobile application may not be able to detect all the values of widely varying energy levels in **Autorange** mode. The autorange function uses the energy level of the last pulse to set the range level. Therefore, it will not detect the next pulses if they are lower than the trigger level. As a result, the autorange may become caught on a high range value. To avoid this problem, select a lower value for the trigger level, change the range manually or reset the **Autorange** mode by reselecting **Auto** in the **Range** menu.



Erratic triggering?

In electrically noisy environments, it is possible that the BLU mobile application will inadvertently trigger on the noise. If this is the case, increase the trigger level to 3% or higher if necessary.

It is always good practice to reduce electrical noise generation or shield the detector and monitor when measuring very low pulse energies.



Figure 29. Corrections setting - tap a number to change it or tap the auto correction switch to activate it

Connection

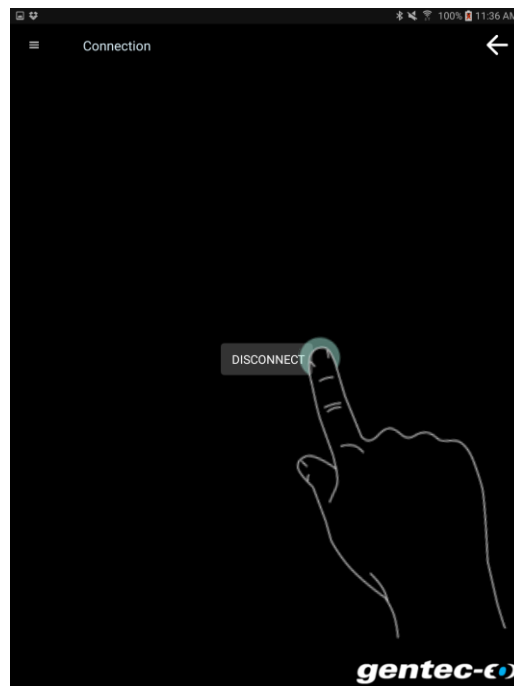

Figure 30. Disconnect setting - tap the **Disconnect** button to disconnect the BLU device

About

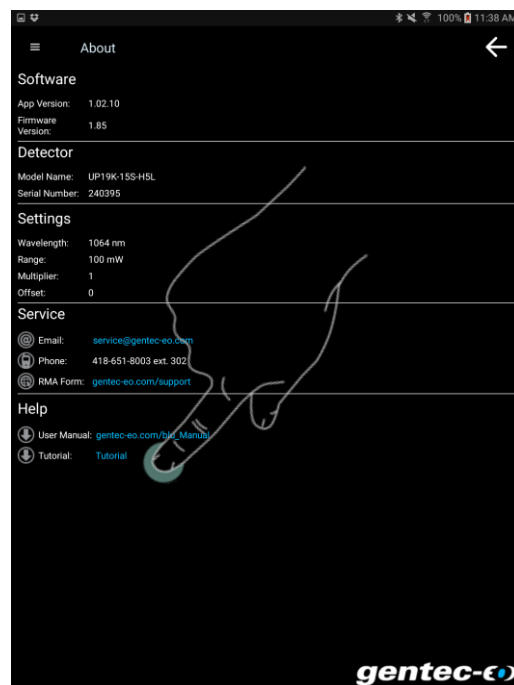

Figure 31. **About** menu - tap a link such as the tutorial to open it

4. SERIAL COMMUNICATION

4.1. DESCRIPTION

The BLU transmits all its information through a set of serial commands. The serial commands can be sent through Bluetooth communication or through USB communication. The BLU mobile app and the PC-Gentec-EO software are basically graphic interfaces that translate serial commands into meaningful buttons and icons.

The USB class used by BLU is a CDC or communications device class. This means it shows up in the host PC as a COM port, but it is not a COM port, rather a true full-speed USB port. Communication is comparable to an RS232 port, but very fast. The USB drivers are installed when you install the PC-Gentec-EO software on your computer.

To simplify Bluetooth connection, we provide a Bluetooth dongle. This key allows a standard virtual COM port communication by taking care of the Bluetooth Stack behind the scenes. However, you still need to select your Bluetooth device by selecting the correct MAC address. The Bluetooth dongle drivers are installed on your computer when you install the PC-Gentec-EO software.

Open the appropriate port in your software with standard COM port tools. None of the port settings matter since they are not used, so leave them at whatever default they are in. It is a real USB connection.

Use the standard COM port writes and reads to control the BLU.

4.2. SETTING UP COMMUNICATION TO THE BLU

4.2.1. Verify the COM port

To verify the USB installation and find the COM port number, click:

Start → Settings → Control panel → System → Device manager

Scroll down to ports (COM & LPT) and double-click that line. One of the options should be

USB-to-Serial Port (COM#)

Note the COM port number. You will need it for the next step.

4.2.2. Connect the BLU

You may use any serial communications software that you are familiar with. Our instructions are for HyperTerminal because it is widely available on PCs with Windows. For Windows 10, you can use equivalent software such as:

- CoolTerm: <https://freeware.the-meiers.org/>
- Putty: <http://www.putty.org/>
- RealTerm: <https://realterm.sourceforge.io/>

Select:

Start → Programs → Accessories → Communications → HyperTerminal

To save communication settings, enter a name for the connection. In the drop-down menu **Connect using...** select the COM port on which the USB driver was installed (Section 4.2.1). Select OK.

Input the following settings into the communications parameter window that appears next.

BLU COM port settings	
Bits per second	Any settings will work
Data bits	Any settings will work
Parity	Any settings will work
Stop bits	Any settings will work
Flow control	Any settings will work

Click OK to begin entering serial commands in the HyperTerminal window.

4.2.3. To echo commands

The commands you type will not appear in the HyperTerminal window unless you set up the HyperTerminal to do so. Only the response from the BLU will be displayed. If you prefer to see the commands you are typing on the HyperTerminal window, click the file menu and execute the following sequence:

File → Properties → Settings → ASCII setup → "Echo typed characters locally" → OK

4.2.4. Test the connection

In the HyperTerminal window, type *VER. If the response is the version of your BLU, you are successfully connected and ready for serial command action.

4.2.5. HyperTerminal settings shortcut

When you end the session, HyperTerminal will ask if you want to save your settings. To avoid inputting the communication parameters again in the future, save by clicking Yes. The next time you execute the string of commands, the name of your session will appear after HyperTerminal. Clicking on the session name will open the connection using the saved settings. To avoid re-entering the string of commands, put a shortcut to this file on your desktop. Search for the file name and select the file. Right click and select **Shortcut** in the drop-down menu.

4.3. SERIAL COMMAND FORMAT

4.3.1. Serial protocol rules

Commands are sent as text strings. The response will either be data or an "ACK".

4.3.2. Text mode rules

All text commands must begin with a trig character (*). You do not need to end it with a line feed or a carriage return. Parameters must NOT be separated by spaces. Characters do not have to be capitals. Mixed upper and lower cases are permitted. Replies to all text mode commands are also in text mode and end with a carriage return and a line feed.

In case of an error, the reply string is in the following format:

Error X: reason [enter]

Where X is the error code, and reason is an explanation. See "Error codes" at the end of this section.

Because all text mode replies end with a carriage return <CR> or a line feed <LF> (or both), a text reply contains tabulations when many elements need to be separated in the string. This is useful when exporting data to a spreadsheet.

4.4. LIST OF SERIAL COMMANDS FOR THE BLU (SUMMARY)

#	Command Name	Command	Description
Display			
01	Set scale	SCS	Manually sets the scale
02	Set scale up	SSU	Changes scale to the next higher scale
03	Set scale down	SSD	Changes scale to the next lower scale
04	Get current scale index	GCR	Returns scale index between 0 and 41
05	Set autoscale	SAS	Sets the autoscale
06	Get autoscale	GAS	Returns autoscale status
07	Display valid scale	DVS	Displays the valid scales for the connected head
08	Set trigger level	STL	Sets the internal trigger level when measuring pulse energy
09	Get trigger level	GTL	Returns trigger level value
10	Get measure mode display	GMD	Returns the current measure mode on BLU
Measurement			
Data acquisition			
11	Query current value	CVU	Gets the value currently displayed on the screen
12	Send continuous transmission of data	CAU	Sends the values in ASCII to the serial port with the data sampling setting
13	Stop the CAU command	CSU	Stops the CAU command
14	Query new value ready*	NVU	Determines if new reading is available or not
Setup			
15	Set personal wavelength correction in nm	PWC	Specifies the wavelength in nm
16	Set personal wavelength correction in μm^*	PWM	Specifies the wavelength in μm
17	Get wavelength	GWL	Returns the wavelength in nm
Control			
18	Set anticipation	ANT	Turns the anticipation on or off
19	Get anticipation status	GAN	Returns the anticipation status
20	Set zero offset	SOU	Zeroes the reading
21	Clear zero offset	COU	Undoes the zeroing of the reading
22	Get zero offset	GZO	Returns the zero offset status
23	Set user multiplier	MUL	Sets the multiplier value
24	Get user multiplier	GUM	Returns the current multiplier value
25	Set user offset	OFF	Sets the offset value
26	Get user offset	GUO	Returns the current offset value
27	Set Single-shot energy mode	SSE	Sets the Single-shot energy mode
28	Query single-shot energy	GSE	Returns to the single-shot energy state
Instrument and detector information			
29	Query version	VER	Gets firmware version of the BLU
30	Query status	STS	Retrieves the detector information and monitor settings
31	Query extended status	ST2	Returns the extended status
32	ID number	IDN	Returns instrument ID
33	Query version*	GSV	Gets firmware version of the BLU with no text
34	Get firmware	GFW	Gets Firmware NIG and Head Type
35	Get state of charge	QSO	Queries battery state of charge
BLU module-related commands			
36	Put the head in sleep mode	SLE	Puts head in sleep mode
37	Communication command	RDY	Used by the software to know if the BLU is connected
38	Set timer before going to sleep	SLT	Sets time before going to sleep

#	Command Name	Command	Description
39	Get sleep timer	GST	Gets sleep timer value
40	Check if USB is plugged	USB	Queries USB and sees if it is plugged in
41	Bluetooth disconnect	BTD	Disconnects the Bluetooth, changes the state of the BLU

* Coming soon

The serial commands format is:

All text commands must begin with a trig character (*) and MUST NOT end with a line feed or a carriage return. All parameters must NOT have a space between the command and the list of parameters, nor between the parameters themselves. The characters do not have to be capitals. Mixed case is good. Replies to all text mode commands are also in text mode and end with a carriage return and line feed.

*MUL+8 character numerical value, i.e., « *MUL1.000000 » or « *MUL-1.34e-3 » or « *MUL0.000543 »

*OFF+8 character numerical value as above

*STL+4 character numerical value as « *STL10.2 » or « *STL0.22 »

*SSE1 / *SSE0: Single Shoot Energy ON or OFF

4.5. LIST OF SERIAL COMMANDS FOR THE BLU (COMPLETE)

4.5.1. Display

01 - Set scale

This command is used to force the display of the current data into a specific scale. The lower scale is always zero, the higher scales can be found in the table below. The **Autoscale** mode applies the best scale for the current values in real time. The parameter must be one of the identifiers in the table below and have two digits.

Command	Parameters	Answer
SCS	Range index	

Range identifiers

Index	Value	Index	Value
00	1 picowatt or picojoule	21	30 milliwatts or millijoules
01	3 picowatts or picojoules	22	100 milliwatts or millijoules
02	10 picowatts or picojoules	23	300 milliwatts or millijoules
03	30 picowatts or picojoules	24	1 watt or joule
04	100 picowatts or picojoules	25	3 watts or joules
05	300 picowatts or picojoules	26	10 watts or joules
06	1 nanowatt or nanojoule	27	30 watts or joules
07	3 nanowatts or nanojoules	28	100 watts or joules
08	10 nanowatts or nanojoules	29	300 watts or joules
09	30 nanowatts or nanojoules	30	1 kilowatt or kilojoule
10	100 nanowatts or nanojoules	31	3 kilowatts or kilojoules
11	300 nanowatts or nanojoules	32	10 kilowatts or kilojoules
12	1 microwatt or microjoule	33	30 kilowatts or kilojoules
13	3 microwatts or microjoules	34	100 kilowatts or kilojoules
14	10 microwatts or microjoules	35	300 kilowatts or kilojoules
15	30 microwatts or microjoules	36	1 megawatt or megajoule
16	100 microwatts or microjoules	37	3 megawatts or megajoules
17	300 microwatts or microjoules	38	10 megawatts or megajoules
18	1 milliwatt or millijoule	39	30 megawatts or megajoules
19	3 milliwatts or millijoules	40	100 megawatts or megajoules
20	10 milliwatts or millijoules	41	300 megawatts or megajoules

Default: autoscale



Example

The following example sets the scale to 30 watts or joules:

Command: *SCS27

Answer:

02 - Set scale up

This command is used to force the display of the current data into a higher scale.

Command	Parameters	Answer
SSU	None	

03 - Set scale down

This command is used to force the display of the current data into a lower scale.

Command	Parameters	Answer
SSD	None	

04 - Get current scale index

This command returns the scale index between 0 and 41. Please refer to the set scale command (SCS) details for the complete scale index table.

Command	Parameters	Answer
GCR	None	Index from 0 to 41



Example

Command: *GCR

Answer: Range: 10<CR><LF>

05 - Set autoscale

This command is used to force the display into autoscale.

Command	Parameters	Answer
SAS	1: on 0: off	

06 - Get autoscale

This command returns whether or not the **Autoscale** option is activated.

Command	Parameters	Answer
GAS	None	1: on 0: off



Example

Command: *GAS

Answer: AutoScale: 1<CR><LF>

07 - Display valid scale

This command is used to display all of the valid scales supported by the connected head. The scales are displayed in scale index. Please refer to the set scale section for the table correspondence.

Command	Parameters	Answer
DVS	None	The valid scale index.

The following example is for a UP19K BLU, which can have the following scales:

- 100 mW
- 300 mW
- 1 W
- 3 W
- 10 W
- 30 W



Example

Command: *DVS	Answer:	[22]: 100.0 m <CR> <LF> [23]: 300 m <CR> <LF> [24]: 1.000 <CR> <LF> [25]: 3.00 <CR> <LF> [26]: 10.00 <CR> <LF> [27]: 30.0 <CR> <LF>
---------------	---------	--

08 - Set trigger level

This command sets the internal trigger level when using the device in **Energy** mode.

Command	Parameters	Answer
STL	Trigger level (in percentage) must be four numerical values	ACK

Default: 2%

The value should be set between 0.1% and 99.9%.



Example

For a UP19K-15S-H5, 30 W max power.

Command: *STL15.4 (15.4%) *STL0.20 (.2%)	Answer: ACK
---	-------------

09 - Get trigger level

This command returns the trigger level in %. The value is between 0.1% and 99.9%.

Command	Parameters	Answer
GTL	None	Returns the trigger level in %



Example

Command: *GTL

Answer: trigger level: 15.4% (4.6 watts) of
max power: 30 watts

10 – Get measure mode display

This command returns the BLU's measurement mode. Depending on the head, it can be a **Power** mode in W or **Single-shot energy** mode in J (SSE).

Command	Parameters	Answer
GMD	None	POWER = 0 SSE = 2



Example

Command: *GMD

Answer: Mode: 0

4.5.2. Data acquisition

11 - Query current value

This command is used to query the value that is currently being displayed by the monitor. The value is displayed in watts or in joules.

Command	Parameters	Answer
CVU	None	Current value



Example

For example, a 12-milliwatt reading would be displayed like this:

```
Command: *CVU           Answer: +4.417128e-01
```

12 - Send continuous transmission of data

This command is used to send data to the serial port, according to the data sampling setting. The transfer speed is 2 Hz.

Command	Parameters	Answer
CAU	None	Data in ASCII

13 - Stop the CAU command

This command is used to stop the real-time transfer enabled by the CAU command.

Command	Parameters	Answer
CSU	None	ACK

14 - Query new value ready

This command is used to check whether a new value is available from the device. Though optional, its use is recommended when used with a single pulse operation.

Command	Parameters	Answer
NVU	None	New data available or New data not available



Example

```
Command: *NVU           Answer: New data not available <CR><LF>
```

15 - Set personal wavelength correction

This command is used to specify the wavelength in nm being used on the detector. The EEPROM in the detector contains measured spectral data for a wide range of wavelengths. If the wavelength input by the user is different from the predefined list of wavelengths on the device, a custom value is interpolated. Specifying zero as a wavelength or providing an out-of-bound value as a parameter restores the default settings. A valid value is set between the lowest and highest wavelengths supported by the device, and it should not be a floating-point value. The input parameter must have five digits. If the desired wavelength does not have five digits, you must enter a zero-padded number. For example, to set the wavelength at 514 nm, you must enter 00514.

Command	Parameters	Answer
PWC	Wavelength in five digits	

Default: calibration wavelength (typically 1064 nm, varies with the detector model)



Example

The following example sets the wavelength to 1550 nm.

Command: *PWC01550

Answer: ACK

16 - Set personal wavelength correction in microns

This command is used to specify the wavelength in microns. The EEPROM in the detector contains measured spectral data for a wide range of wavelengths. A valid value is set between the lowest and highest wavelengths supported by the device. The input parameter must have five digits and can be a floating-point value. If the desired wavelength does not have five digits, you must enter a zero-padded number. For example, to set the wavelength at 10.6 microns, you must enter 010.6.

Specifying zero as a wavelength or providing an out-of-bound value as a parameter cancels the command.

Command	Parameters	Answer
PWM	Wavelength in five digits	

Default: calibration wavelength (typically 1064 nm, varies with the detector model)



Example

The following example sets the wavelength to 2.5 microns (2500 nm).

Command: *PWM02.50

Answer:

17 - Get wavelength

This command returns the wavelength in nm.

Command	Parameters	Answer
GWL	None	Returns the wavelength in nm



Example

Command: *GWL

Answer: PWC: 1064

4.5.3. Control

18 - Set anticipation

This command is used to enable or disable the anticipation processing when the device is reading from a wattmeter. The anticipation is a software-based acceleration algorithm that provides faster readings using the detector's calibration.

Command	Parameters	Answer
ANT	1: on 0: off	

Default: on



Example

The following example sets the anticipation on.

Command: *ANT1

Answer: ACK

19 - Get anticipation status

This command returns the anticipation status. If the anticipation is not available, it will always be off.

Command	Parameters	Answer
GAN	None	1: on 0: off



Example

Command: *GAN

Answer: Anticipation: 0

20 - Set zero offset

This command subtracts the current value from all future measurements the moment the command is issued to set a new zero point.

Command	Parameters	Answer
SOU	None	The BLU takes a zero (red LED flashing for about 3 seconds) and ACK.

21 - Clear zero offset

This command undoes the zero offset command to set the zero point at zero.

Command	Parameters	Answer
COU	None	ACK

22 - Get zero offset

This command returns whether the zero offset has been activated before or not.

Command	Parameters	Answer
GZO	None	Zero activation status



Example

```
Command: *GZO           Answer: Zero: 1 or Zero: 0
```

23 - Set user multiplier

This command is used to set the value of the multiplier.

Command	Parameters	Answer
MUL	8-character numerical value	ACK

Default: 1



Example

The following example sets multiplier = 33

```
Command: *MUL00000033   Answer: ACK
          or
          *MUL3.3000e1
```

24 - Get user multiplier

This command returns the multiplier value.

Command	Parameters	Answer
GUM	None	Current multiplier value



Example

```
Command: *GUM           Answer: User multiplier: 3.3000000e+01
```

25 - Set user offset

This command is used to set the value of the offset manually instead of using the automatic zeroing with the command *SOU.

Command	Parameters	Answer
OFF	Eight-character numerical value	ACK

Default: 0



Example

The following example sets offset to 1.5 milliwatt.

```
Command: *OFF0.001500      Answer: ACK
         or
         *OFF1.500e-3
```

The other option available is the zero offset. The zero offset operation is done first, before the user multipliers and offsets.

26 - Get user offset

This command returns the offset value.

Command	Parameters	Answer
GUO	None	Current offset value



Example

```
Command: *GUO      Answer: User offset: 1.500e-3
```

27 - Set single-shot energy mode

This command is used to toggle to **Single-shot energy** mode when using a wattmeter.

Command	Parameters	Answer
SSE	1: on 0: off	ACK

Default: off

28 – Query Single-shot energy mode

This command is used to read the current status of the **Single-shot energy** mode.

Command	Parameters	Answer
GSE	None	SSE: 1



Example

```
Command: *GSE      Answer: SSE: 1
```

4.5.4. Instrument and detector information

29 - Query version

This command is used to query the device to get information about the firmware version and the device type.

Command	Parameters	Answer
VER	None	Version and device type



Example

Command: *VER

Answer: BLU firmware version 1.80

30 - Query status

This command is used to query the device to get information about the following characteristics:

- Measure mode
- Maximum, minimum and current scale
- Maximum, minimum and current wavelength with and without attenuation
- Attenuator availability and status
- Detector model
- Detector serial number

Command	Parameters	Answer
STS	None	A hexadecimal structure described in the table below

The first byte represents the validity of the structure: 0 represents a valid line while 1 is the end of the structure. The next 4 bytes represent the address line, and the last 4 bytes are the actual value. The values are written on 32 bits, which means that all the values are written on two lines. The first line represents the LSB, and the second line represents the MSB.

The following table shows the output WITH a XLP12-3S-H2-INT-D0 (s/n 199672).

Hexadecimal structure			Converted value	Definition
Valid	Address	Value		
:0	0000	0003	3	Reserved
:0	0001	0000	0	Reserved
:0	0002	0003	3	Reserved
:0	0003	0000	0	Reserved
:0	0004	0000	0	Measure mode LSB
:0	0005	0000	0	Measure mode MSB
:0	0006	0015	21	Current scale LSB (refer to scale index *SCS)
:0	0007	0000	0	Current scale MSB (refer to scale index *SCS)
:0	0008	0019	25	Maximum scale LSB (refer to scale index *SCS)
:0	0009	0000	0	Maximum scale MSB (refer to scale index *SCS)
:0	000A	0011	17	Minimum scale LSB (refer to scale index *SCS)
:0	000B	0000	0	Minimum scale MSB (refer to scale index *SCS)
:0	000C	0428	1064	Current wavelength LSB (nm)
:0	000D	0000	0	Current wavelength MSB (nm)
:0	000E	2968	10600	Maximum wavelength LSB (nm)
:0	000F	0000	0	Maximum wavelength MSB (nm)
:0	0010	00C1	193	Minimum wavelength LSB (nm)
:0	0011	0000	0	Minimum wavelength MSB (nm)
:0	0012	0001	1	Is attenuator available LSB (1= yes 0 = no)
:0	0013	0000	0	Is attenuator available MSB (1= yes 0 = no)
:0	0014	0000	0	Is attenuator on LSB (1= yes 0 = no)
:0	0015	0000	0	Is attenuator on MSB (1= yes 0 = no)
:0	0016	2968	10600	Maximum wavelength with attenuation LSB (nm)
:0	0017	0000	0	Maximum wavelength with attenuation MSB (nm)
:0	0018	00C1	193	Minimum wavelength with attenuation LSB (nm)
:0	0019	0000	0	Minimum wavelength with attenuation MSB (nm)
:0	001A	4C 58	X L	Detector name (you must convert the hexadecimal values into ASCII characters)
:0	001B	31 50	P 1	
:0	001C	2D 32	2 -	
:0	001D	53 33	3 S	
:0	001E	- H		
:0	001F	2 -		
:0	0020	D 0		
:0	0021			0000 = null termination character
:0	0022			The rest of the characters are not valid until line 002A
:0	0023			
:0	0024			
:0	0025	40 03	@	
:0	0026	00 1A		
:0	0027	00 00		
:0	0028	E1 20	á	
:0	0029	00 3A	:	
:0	002A	39 31	1 9	Detector serial number (you must convert the hexadecimal values into ASCII characters)
:0	002B	36 39	9 6	
:0	002C	32 37	7 2	
:0	002D	00 00		0000 = null termination character
:1	0000	00 00		End of structure

31 - Query extended status

This command is used to query the device to get information about the following characteristics:

- Measure mode
- Maximum, minimum and current scale
- Maximum, minimum and current wavelength with and without attenuation
- Attenuator availability and status
- Detector model
- Detector serial number
- Trigger level (0.001 to 0.999)
- Autoscale mode
- Anticipation mode
- Zero offset mode
- User multiplier
- User offset

Command	Parameters	Answer
ST2	None	A hexadecimal structure described in the table below.

The first byte represents the validity of the structure: 0 represents a valid line while 1 is the end of the structure. The next 4 bytes represent the address line, and the last 4 bytes are the actual value. The values are written on 32 bits, which means that all the values are written on two lines. The first line represents the LSB, and the second line represents the MSB.

The following table shows the output WITH a XLP12-3S-H2-INT-D0 (s/n 199672).

Hexadecimal structure			Converted value	Definition
Valid	Address	Value		
:0	0000	3	3	Reserved
:0	0001	0	0	Reserved
:0	0002	3	3	Reserved
:0	0003	0	0	Reserved
:0	0004	0	0	Measure mode LSB
:0	0005	0	0	Measure mode MSB
:0	0006	11	17	Current scale LSB (refer to scale index *SCS)
:0	7	0	0	Current scale MSB (refer to scale index *SCS)
:0	0008	19	25	Maximum scale LSB (refer to scale index *SCS)
:0	0009	0	0	Maximum scale MSB (refer to scale index *SCS)
:0	000A	11	17	Minimum scale LSB (refer to scale index *SCS)
:0	000B	0	0	Minimum scale MSB (refer to scale index *SCS)
:0	000C	428	1064	Current wavelength LSB (nm)
:0	000D	0	0	Current wavelength MSB (nm)
:0	000E	2968	10600	Maximum wavelength LSB (nm)
:0	000F	0	0	Maximum wavelength MSB (nm)
:0	0010	00C1	193	Minimum wavelength LSB (nm)
:0	0011	0	0	Minimum wavelength MSB (nm)
:0	0012	1	1	Is attenuator available LSB (1 = yes, 0 = no)
:0	0013	0	0	Is attenuator available MSB (1 = yes, 0 = no)
:0	0014	0	0	Is attenuator on LSB (1 = yes, 0 = no)
:0	0015	0	0	Is attenuator on MSB (1 = yes, 0 = no)
:0	0016	2968	10600	Maximum wavelength with attenuation LSB (nm)
:0	0017	0	0	Maximum wavelength with attenuation MSB (nm)

Hexadecimal structure			Converted value	Definition
Valid	Address	Value		
:0	0018	00C1	193	Minimum wavelength with attenuation LSB (nm)
:0	0019	0	0	Minimum wavelength with attenuation MSB (nm)
:0	001A	4C 58	X L	Detector name (you must convert the hexadecimal values in ASCII characters)
:0	001B	31 50	P 1	
:0	001C	2D 32	2 -	
:0	001D	53 33	3 S	
:0	001E	48 2D	- H	
:0	001F	2D 32	2 -	
:0	0020	30 44	D 0	
:0	0021	0 0		0000 = null termination character
:0	0022	0 0		The rest of the characters are not valid until line 002A
:0	0023	0 0		
:0	0024	1F 0		
:0	0025	40 3	@	
:0	0026	0 1A		
:0	0027	0 0		
:0	0028	E1 20	Á	
:0	0029	0 3A	:	
:0	002A	39 31	1 9	Detector name (you must convert the hexadecimal values into ASCII characters)
:0	002B	36 39	9 6	
:0	002C	32 37	7 2	
:0	002D	0 0		0000 = null termination character
:0	002E	D70A		Reserved
:0	002F	3CA3		Reserved
:0	0030	0001	1	Is autoscale mode on? LSB
:0	0031	0000	0	Is autoscale mode on? MSB
:0	0032	0000	0	Is anticipation on? LSB
:0	0033	0000	0	Is anticipation on? MSB
:0	0034	0000	0	Is zero offset on? LSB
:0	0035	0000	0	Is zero offset on? MSB
:0	0036	0000	1.0000	Correction multiplier LSB
:0	0037	3F80		Correction multiplier MSB
:0	0038	0000	0.0000	Correction Offset LSB
:0	0039	0000		Correction offset MSB
:1	0000	0000	0	End of structure

32 – Query identifier

This command is used to query the device to get information about the device type.

Command	Parameters	Answer
IDN	None	Device type

33 - Query version (no text)

This command is used to query the device to get information about the firmware version and the device type.

Command	Parameters	Answer
GSV	None	Firmware version no text



Example

```
Command: *GSV           Answer: 1.80
```

34 - Query head type

This command is used to get information about the firmware version, the NIG number of the firmware and the type of detector.

Command	Parameters	Answer
GFW	None	Firmware NIG number, type of detector and firmware version



Example

```
Command: *GFW           Answer: 104552, wattmeter, 1.80
```

35 – Query battery state

This command is used to get the battery power in percentages.

Command	Parameters	Answer
QSO	None	Number in percentage



Example

```
Command: *QSO           Answer: 98 <CR><LF>
```

36 – Put the head in sleep mode

This command will put the head into sleep. This will end the communication with the BLU mobile app or the PC-Gentec-E0 software.

Command	Parameters	Answer
SLE	None	Turn the BLU off



Example

```
Command: *SLE           Answer: ACK
```

37 – Connection confirm command

This command is sent by the BLU mobile app or the PC-Gentec-EO software to confirm the connection with the BLU module. This command will change the state of the BLU from searching a connection state (blue led flashing quickly) to the connected state (blue led flashing slowly).

Command	Parameters	Answer
RDY	None	ACK



Example

Command: *RDY

Answer: ACK

38 – Set sleep timer

This command will set the time before the BLU stops looking for a connection and goes to sleep. By default, this value is set at 5 minutes.

Command	Parameters	Answer
SLT	Time before sleep in minutes (must be four digits)	ACK



Example

Command: *SLT0005

ACK

39 – Get sleep timer

This command will query the value of the timer before going to sleep.

Command	Parameters	Answer
GST	None	Value of off timer

40 – Get USB state

This command will check if the USB cable is plugged in.

Command	Parameters	Answer
USB	None	1: USB connected, 0: USB not connected

41 – Bluetooth disconnect

This command will disconnect the BLU from the BLU mobile app or the PC-Gentec-EO software. Sending this command is required to correctly terminate a communication link. The BLU will return to the state where it is looking for a connection, and the blue LED will flash rapidly.

Command	Parameters	Answer
BTD	None	ACK

4.6. ERROR MESSAGES

#	Error	Comment
1	Command not found	Command is invalid

5. USB DRIVER INSTALLATION

BLU USB drivers will install a virtual COM port on your PC. Please download the USB driver at: <https://gentec-eo.com/downloads>.

- Do not connect the BLU to your computer.
- Choose the appropriate operating system corresponding to your computer.

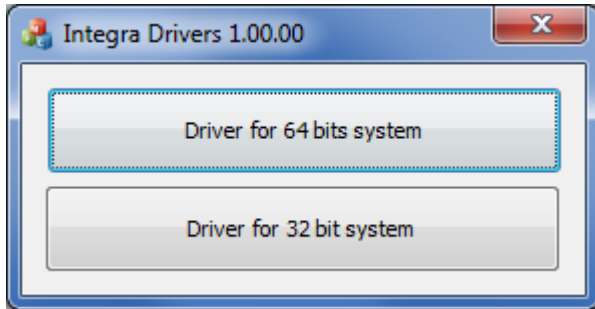

- Follow the installation steps until you have the message "Ready to use".

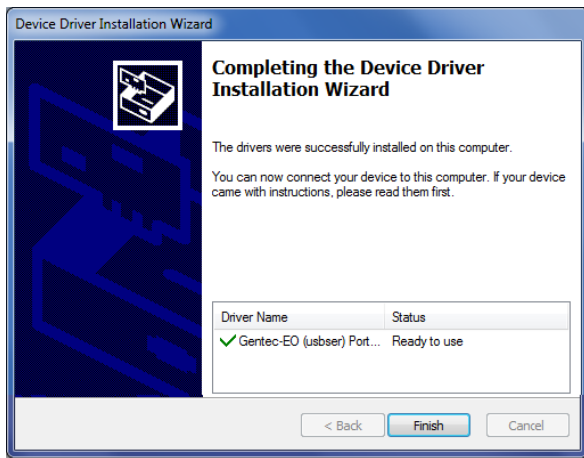
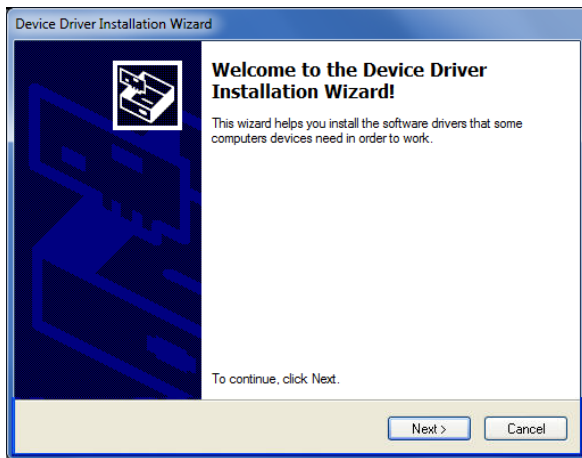

- You can now connect the BLU and install the software.

6. MAINTENANCE

6.1. FREE SOFTWARE AND FIRMWARE UPGRADE

Keep up to date with the latest versions of the PC-Gentec-EO software and the BLU mobile application to get the newest features and options. As new and improved versions of the device's firmware are created, it is in your best interest to update your BLU. The latest device firmware can be downloaded from the Gentec-EO website at <https://gentec-eo.com/downloads>. Find the file that corresponds to your BLU and follow our simple, easy-to-use instructions.

6.2. TROUBLESHOOTING

When using the BLU with serial commands, please make sure to always close the communication port after you are done using the BLU. If you do not do so, the BLU will not be recognized the next time you connect it to the computer.

7. DECLARATION OF CONFORMITY

Application of Council Directive: 2014/30/EU The EMC Directive



Manufacturer's name: Gentec Electro Optics, Inc.
 Manufacturer's address: 445, Saint-Jean-Baptiste, Suite 160
 Québec (Québec) Canada G2E 5N7

European representative name: Laser Components S.A.S.
 Representative's address: 45 bis Route des Gardes
 92190 Meudon (France)

Type of equipment: Embedded monitor
 Model No.: BLU series
 Year of test and manufacture: 2016

Standards to which conformity is declared:

Emissions

Result	Product standard	Test standard	Description
Pass	EN 61326-1_Ed2:2013 (IEC		

Immunity

Result	Product standard	Test standard	Description	Performance Criteria	Test levels
Pass	EN 61326-1_Ed2:2013 (IEC 61326-1_Ed2:2012)	IEC 61000-4-2:2008Ed. 2	Electrostatic Discharge Immunity	Criteria B	4 kV contact discharge 8 kV air discharge
Pass	EN 61326-1_Ed2:2013 (IEC 61326-1_Ed2:2012)	IEC 61000-4-3:2006+A1:2007+A2:2010	RF Conducted Immunity	Criteria A	3 Vrms, 150 kHz to 80 MHz

I, the undersigned, hereby declare that the equipment specified above conforms to the above directives and standards.

Place: Québec (Québec)
 Date: September 15, 2016

8. UKCA DECLARATION OF CONFORMITY

Application of Council Directive: 2014/30/EU The EMC Directive

Manufacturer's name: Gentec Electro Optics, Inc.
 Manufacturer's address: 445, Saint-Jean-Baptiste, Suite 160
 Québec (Québec) Canada G2E 5N7

European representative name: Laser Components S.A.S.
 Representative's address: 45 bis Route des Gardes
 92190 Meudon (France)

Type of equipment: Embedded monitor
 Model No.: BLU series
 Year of test and manufacture: 2016

Standards to which conformity is declared:

Emissions

Result	Product standard	Test standard	Description
Pass	EN 61326-1_Ed2:2013 (IEC		

Immunity

Result	Product standard	Test standard	Description	Performance Criteria	Test levels
Pass	EN 61326-1_Ed2:2013 (IEC 61326-1_Ed2:2012)	IEC 61000-4-2:2008Ed. 2	Electrostatic Discharge Immunity	Criteria B	4 kV contact discharge 8 kV air discharge
Pass	EN 61326-1_Ed2:2013 (IEC 61326-1_Ed2:2012)	IEC 61000-4-3:2006+A1:2007+A2:2010	RF Conducted Immunity	Criteria A	3 Vrms, 150 kHz to 80 MHz

I, the undersigned, hereby declare that the equipment specified above conforms to the above directives and standards.

Place: Québec (Québec)
 Date: November 22, 2021

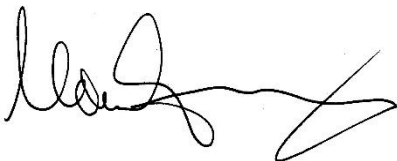



9. FCC DECLARATION OF CONFORMITY

Manufacturer's name: Gentec Electro Optics, Inc.
 Manufacturer's address: 445, Saint-Jean-Baptiste, Suite 160
 (Québec) Canada G2E 5N7

Type of equipment: Embedded monitor
 Model No.: BLU series
 Year of test and manufacture: 2016-2017

FCC ID: T7V1740

IC registration number: 216Q-1740

MIC ID: [R]202-SMF099

Result	Specifications	Description
Pass	FCC 47 CFR Part 15 Sub-part C, §15.247	Operation in the 902-928 MHz, 2400-2483.5 MHz, 5725-5850 MHz.
Pass	RSS-247. Issue 1, May 2015, Section 5	Digital Transmission System (DTSSs), Frequency Hopping Systems (FHSs) and Licence-Exempt Local Area Network (LE-LAN) Devices.
Pass	Ordinance concerning Technical Regulations Conformity, Certification etc. of specified Radio Equipment Article 2, Clause 1, Item 19	Low power data communications system in the 2.4 GHz band

I, the undersigned, hereby declare that the equipment specified above conforms to the above directives and standards.

Place: Québec (Québec)

Date: January 3, 2019

10. APPENDIX A: WEEE DIRECTIVE

Recycling and Separation Procedure for WEEE Directive 2002/96/EC

This section is used by the recycling center when the monitor reaches the end of its life. Breaking the calibration seal or opening the monitor will void the BLU warranty. With respect to the head, please refer to the head's manual.

The complete monitor contains:

- one monitor
- one calibration certificate

Sorting

Paper: certificate

Printed circuit board: inside the detector

Aluminum: detector casing

Plastic: parts inside the detector

Li-ion cell: battery

Plastic: BLU enclosure

Printed circuit board: inside the BLU (no need to separate less than 10 cm²)

LEADER IN LASER BEAM MEASUREMENT SINCE 1972



POWER & ENERGY METERS



BEAM PROFILING



THZ MEASUREMENT

CANADA

445 St-Jean-Baptiste, Suite 160
Quebec, QC, G2E 5N7
CANADA

T (418) 651-8003
F (418) 651-1174

info@gentec-eo.com

UNITED STATES

5825 Jean Road Center
Lake Oswego, OR, 97035
USA

T (503) 697-1870
F (503) 697-0633

info@gentec-eo.com

JAPAN

Office No. 101, EXL111 building,
Takinogawa, Kita-ku, Tokyo
114-0023, JAPAN

T +81-3-5972-1290
F +81-3-5972-1291

info@gentec-eo.com

CALIBRATION CENTERS

- 445 St-Jean-Baptiste, Suite 160
Quebec, QC, G2E 5N7, CANADA
- Werner von Siemens Str. 15
82140 Olching, GERMANY
- Office No. 101, EXL111 building,
Takinogawa, Kita-ku, Tokyo
114-0023, JAPAN